



## CONCEAL

### CABLE MANAGEMENT

The CONCEAL expands and retracts to keep cables organized under a height adjustable table base.

- Total Height: 53.5"
- Total # of links: 23
- Links are detachable
- Weighted bottom
- Attaches to bottom of work surface

PART #

- CONCEAL-GRY
- CONCEAL-BLK

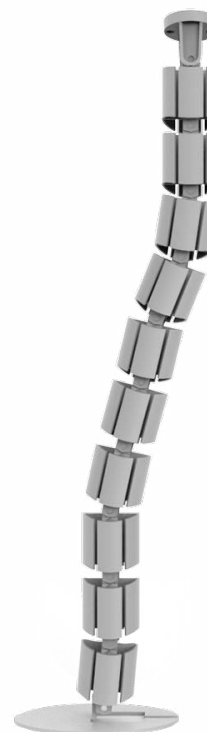

# Touchboards

205 Westwood Ave, Long Branch, NJ 07740  
 Phone: 866-94 BOARDS (26273) / (732)-222-1511  
 Fax: (732)-222-7088 | E-mail: sales@touchboards.com

[esiergo.com](http://esiergo.com) | 800.833.3746

Woman-Owned Business • GSA Contract Holder • CAP & GIZA • Project Matrix • ICE

**esi** ergonomic solutions  
 Workplace comfort. Simplified.

V28 Catalog

**CONCEAL**  
TOP CONNECTOR

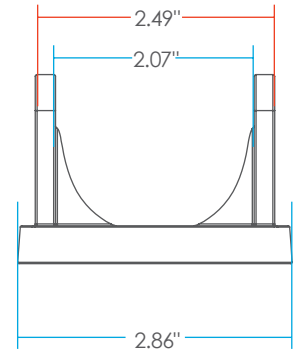
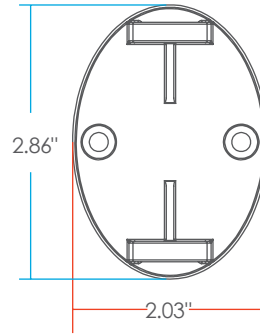
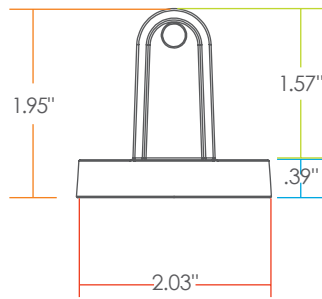
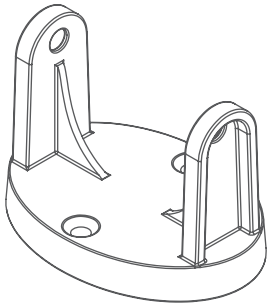

**CONCEAL**  
LINK

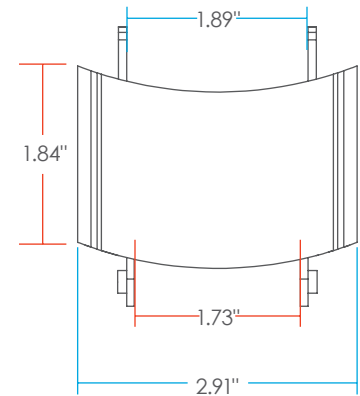
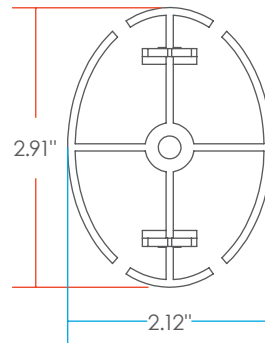
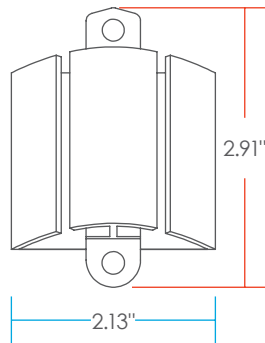
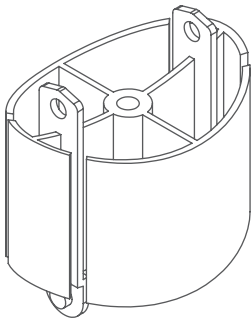

**CONCEAL**  
BASE

