

Supplement to Catalog



Table of Contents

Workstations	2
Desk Mounts	2
Carts	5
Command Post - Components	7
Wall Mounts	8
Accessories	8

Work Stations



WorkFit-A, LCD HD with Worksurface+

WorkFit-A, Dual with Worksurface+

Part # (color)	24-275-026 (polished aluminum)	24-272-026 (polished aluminum)
Includes	Arm, LCD pivot, worksurface, keyboard tray, desk clamp, complete hardware kit	Arm, two (2) LCD pivots, worksurface, keyboard tray, desk clamp, complete hardware kit
Typical LCD Size	≤ 30"	≤ 22" Maximum LCD outside width: 21.25" (54 cm)
<small>LCD SIZE IS APPROXIMATION. DIMENSION IS DIAGONAL MEASUREMENT OF SCREEN. LCD SIZE MAY BE EXCEEDED AS LONG AS SCREEN WEIGHT DOES NOT EXCEED MAXIMUM WEIGHT CAPACITY OF THE MOUNT.</small>		
Weight Capacity	10–20 lbs (4,5–9,1 kg) See website for details	9–20 lbs (4,1–9,1 kg) See website for details
Lift	LCD and keyboard adjust 20" (51 cm) in tandem; LCD adjusts 5" (13 cm) independently. See website for details.	LCD and keyboard adjust 20" (51 cm) in tandem; LCD adjusts 5" (13 cm) independently. See website for details.
Tilt	30°	30°
Pan	180°	180°
Rotation	360° Portrait to landscape screen rotation	360° Portrait to landscape screen rotation
VESA	MIS-D See website for details	MIS-D See website for details
Warranty	5 years	5 years



WorkFit C-Mod, LCD LD

Part # (color)	Light Duty 24-198-055 (two-tone grey)
Typical LCD Size	≤ 22"
<small>LCD SIZE IS APPROXIMATION. DIMENSION IS DIAGONAL MEASUREMENT OF SCREEN. LCD SIZE MAY BE EXCEEDED AS LONG AS SCREEN WEIGHT DOES NOT EXCEED MAXIMUM WEIGHT CAPACITY OF THE MOUNT.</small>	
Weight Capacity	LCD Pivot capacity 5–18 lbs (2,3–8,1 kg) Maximum load on height-adjustment assembly 37 lbs (16,8 kg). Includes weight of display in addition to contents on Worksurface and in Cable Storage Box
Lift	25" (63 cm)
Tilt	25°
Pan	—
Rotation	360° Portrait to landscape screen rotation
VESA	MIS-D
Warranty	5 years

Desk Mounts

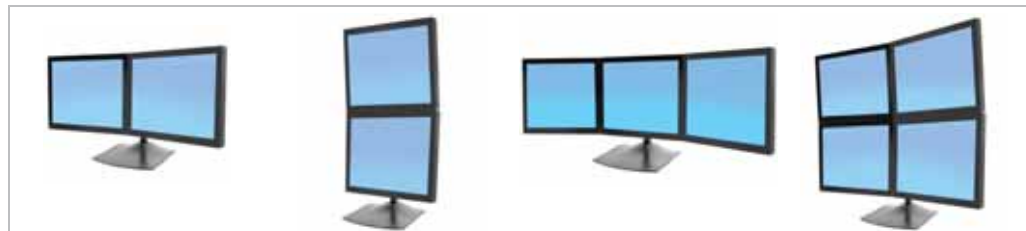

DS100 Dual-Monitor Desk Stand Horizontal

DS100 Dual-Monitor Desk Stand Vertical

DS100 Triple-Monitor Desk Stand Horizontal

DS100 Quad-Monitor Desk Stand

Part # (color)	33-322-200 (black), available Americas, EMEA	33-091-200 (black)	33-323-200 (black), available Americas, EMEA	33-324-200 (black)
Base	Grommet mount base also available (60-350-200). Order separately.	Grommet mount base also available (60-350-200). Order separately.	Grommet mount base also available (60-350-200). Order separately.	Grommet mount base also available (60-350-200). Order separately.
Typical LCD Size	≤ 24" Maximum LCD outside width 23¼" (59 cm)	≤ 24"	≤ 21" (53 cm) Maximum LCD outside width 20" (51 cm)	≤ 24" Maximum LCD outside width 23¼" (59 cm)
<small>LCD SIZE IS APPROXIMATION. DIMENSION IS DIAGONAL MEASUREMENT OF SCREEN. LCD SIZE MAY BE EXCEEDED AS LONG AS SCREEN WEIGHT DOES NOT EXCEED MAXIMUM WEIGHT CAPACITY OF THE MOUNT.</small>				
Weight Capacity	31 lbs (14 kg) per LCD	23 lbs (10,4 kg) per LCD	31 lbs (14 kg) per LCD	31 lbs (14 kg) per LCD
Lift	—	—	—	—
Tilt	—	180°	—	—
Pan	—	180°	—	—
Rotation	360° Portrait to landscape screen rotation	360° Portrait to landscape screen rotation	360° Portrait to landscape screen rotation	360° Portrait to landscape screen rotation
VESA	MIS-D	MIS-D	MIS-D	MIS-D
Warranty	5 years	5 years	5 years	5 years

Desk Mounts

DS100 Desk Stands Individual Components

28" Pole

20-137-200 black

Shipping weight: 5 lbs (2.3 kg)

The DS Pole measures 1-1/2" (38 mm) in diameter and mounts to a Free Standing, Desk Clamp or Grommet Mount Base*

*Attaches to base with set screws from base mounting kit.



Free Standing Base

Flexible, quick, DS mounting

33-262-200 black

Shipping weight: 2 lbs (.9 kg)

Place directly on works surface, no hardware necessary.*

*Observe balance requirements to prevent tipping.



Grommet Mount Base

Quick, stable mounting utilizes grommet hole

60-350-200 black

Shipping weight: 5 lbs (2.3 kg)

Attaches to openings in worksurface from 3/8–3" in diameter (10 to 76 mm) and up to 3-1/4" (83 mm) thick.



DS Clamping Pivot

Single Pivot with P/L motion

47-058-200 black

LCD weights (each): 25 lbs (11.3 kg)
Shipping weight: 4 lbs (1.8 kg)

Attaches to 28" Pole.

Observe balance requirements to prevent tipping.



DS Clamping Double Pivot

Double Pivot with P/L motion

47-051-200 black

LCD weights (each): 23 lbs (10.4 kg)
Shipping weight: 5 lbs (2.3 kg)

Attaches to 28" Pole.

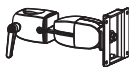

Outboard Pole Clamps

Greater stability for expanded, multi-display configurations

60-443-200* black

Shipping weight: 3 lbs (1.4 kg)

Attaches 55" Crossbar using two (2) base/Pole assemblies.

*One set consists of two (2) clamps.

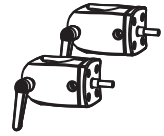

DS Sliding Pivot

Flexible, quick, DS mounting

47-100-009 black

LCD weights (each): 28 lbs (12.7 kg)
Shipping weight: 2 lbs (.9 kg)

Attaches to Crossbar

Observe balance requirements to prevent tipping.



28" Crossbar

For multi-display applications

60-409-200 black

Shipping weight: 6 lbs (2.7 kg)

Attaches to 28" pole.

Requires two (2) Sliding Pivots, order separately.

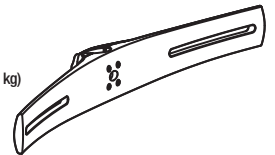

Crossbar Extender

Short

97-446-200 black

Shipping weight: 6 lbs (2.7 kg)

Use Short Extenders to increase width of 28" Crossbar, 60-409 to 46". Includes center pivot for mounting an LCD in the middle of the crossbar.

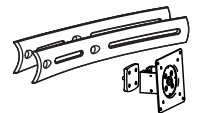

Crossbar Extender

Long

97-447-200 black

Shipping weight: 6 lbs (2.7 kg)

Use Long Extenders to increase width of 28" Crossbar, 60-409-200 to 55". Includes center pivot for mounting an LCD in the middle of the crossbar.

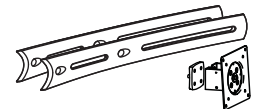

Desk Mounts

1 1/2" Diameter Pole Components

1 1/2" Round Pole, 28" long

20-137-200 black

Mount Pole to worksurface using Grommet Mount Base, 60-350-00

Dimensions: 1 1/2" diameter, 28" (71 cm) Long
Shipping Weight: 5 lbs (2.3 kg)



Split Pole-Mount Bracket

60-423-003 aluminum

Split Pole-Mount Bracket (1 Bracket) - use to mount LX, 200, 400 Series, Extenders, CPU Holders, and Wire Storage Basket on vertical 1 1/2" Round Pole*

Shipping Weight: 2 lbs (.9 kg)

* Order two Brackets for LX, 200, 400 Series and Extenders installation.

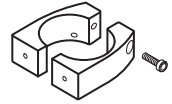

Grommet Mount Base

60-350-200 black

Grommet Mount Base for 1 1/2" Round Pole attaches to worksurface through holes 3/8" to 3" (10 to 76 mm) wide, up to ≤ 4" (102 mm) thick

Shipping Weight: 5 lbs (2.3 kg)



Large Clamp

60-420-200 aluminum

Large Clamp features adjustment lever for easy height repositioning. Applications: LX, 200 Series on 1 1/2" Round Pole

Shipping Weight: 3 lbs (1.4 kg)

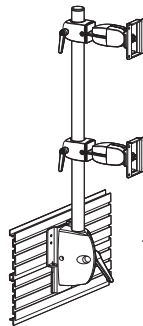

1 1/2" Pole mounted to slatwall with Large Clamp

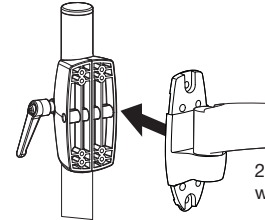

200 Series mount with Large Clamp

Slatwall Components

Slatwall Brackets

Attach LX, MX, 200 and 100 Series Mounting Solutions slatwall. Standard color is black.

Slatwall Bracket
60-271-009* black
(not available in EMEA)
Shipping Weight: 2 lbs (.9 kg)

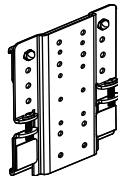

* Woodtronic, Knoll, Infra-structure, Evans, Eurocraft, Teknion, Steelcase, EDP, CBA, Kimball, Innovant



LX Wall Mount Arm

Sample Configurations

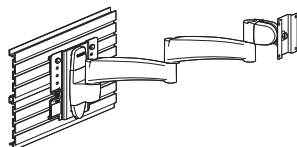
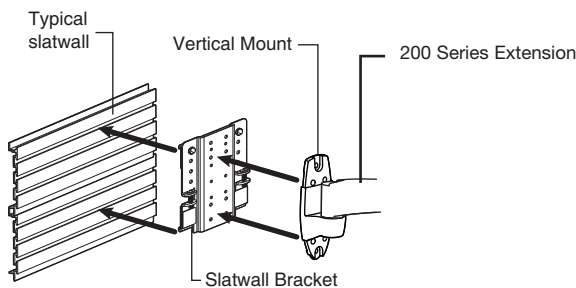

Carts

Mobile WorkStand Cart

Mobile WorkStand

Configure a mobile mounting solution that works for you

No matter how demanding the mobile computing application, or what type of computing equipment you need to mobilize, Ergotron has a computer cart to get the job done. The Mobile WorkStand integrates technology and convenience, allowing the user to move a computer system from room to room. It quickly adjusts to a sitting or standing user height, providing an ergonomically-correct work environment at all times.

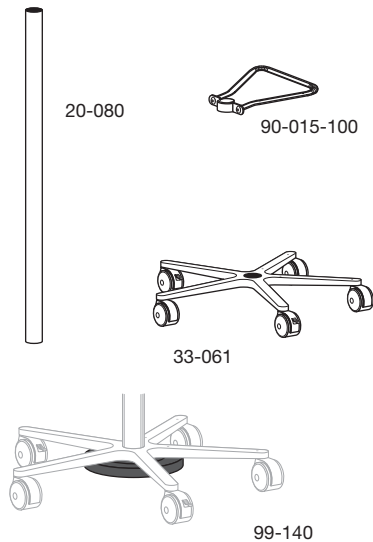

Configure Your Own Mobile WorkStand

Start with the basic components below. Then add peripherals and components from selections on the next page. Finally, choose arms/pivots to mount your monitor, keyboard and/or laptop: Ergotron's LX, 400 and 200 Series mounting solutions are all compatible with Mobile WorkStand.

Part Number	Description	Dimensions H x W x D	Shipping Weight
20-080, chrome	2" Round Pole	48" x 2" x 2" (1270 x 51 x 51 mm)	7 lbs (3.2 kg)
33-061, black	Base & Casters	7" x 27" x 27" (178 x 686 x 686 mm)	13 lbs (5.9 kg)
90-015-100, chrome	Handle	1" x 9-1/4" x 11" (25 x 235 x 279 mm)	2 lbs (.9 kg)
99-140*, black	Stabilizer Weight 25 lbs (11.4 kg)	1" x 11-1/4" x 11-1/4" (25 x 286 x 286 mm)	26 lbs (11.8 kg)



Mobile WorkStand with 400 Series LCD and Keyboard Arms offer vertical adjustment range of 22"-24" (56-61 cm) for sit-to-stand flexibility



Mobile WorkStand with LX Laptop Arm - pole mount brackets allow easy attachment of many Ergotron mounts, placed at any point along the pole



Ergotron's Universal CPU Holder attaches to the base and accommodates a wide range of CPU/UPS sizes

Carts

Mobile WorkStand Cart



99-068-100

Part Number	Description	Dimensions H x W x D	Shipping Weight
99-068-100*	Wire Storage Basket	6-1/8" x 13-1/8" x 4-1/8" (156 x 333 x 105 mm)	3 lbs (1.4 kg)

* Requires separately ordered Pole Mount Bracket. May be mounted to Bracket shared by another component.

Brackets to Mount Arms & Peripherals to Mobile WorkStand

For both arms/pivots and peripherals*, select the appropriate bracket listed below. Attach anywhere along the Pole.

Part Number	Description	Application	Shipping Weight
60-131-003, aluminum	Pole Mount Brackets (2 Brackets)	Mounts LX, 400, 200 Series and 400 Combo	2 lbs (.9 kg)
60-144-003, aluminum	Pole Mount Bracket (1 Bracket)	Mounts CPU Holders and Wire Storage Basket	1 lbs (.5 kg)
60-199-003**, aluminum	Split Pole Bracket (1 Bracket)	Mounts LX, 400 & 200 Series, 400 Combo, CPU Holders and Storage Basket For use with Pole having no open end – facilitates mounting after Mounting Solutions are in place	2 lbs (.9 kg)
97-094-099, grey	Pole Bracket Kit (1 bracket, 1 plate)	Mounts 100 Series to 2" Pole	2 lbs (.9 kg)

* Refer to the peripheral's description to see whether Bracket is necessary.

** LX, 400, 200 Series, and 400 Combo require two Brackets for installation.

Note: Brackets provide attachment holes on two sides. This allows an additional Arm or peripheral to be mounted on the opposite side.

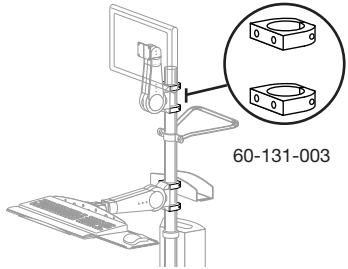

60-131-003

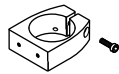

60-144-003

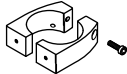

60-199-003

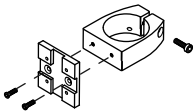

97-094-099

2" Diameter Pole Components

2" Round Pole, 50" long

20-080-100 chrome

Use in conjunction with appropriate Bracket for mounting Ergotron LX, 200, 400 Series, Extenders, CPU Holders, Wire Storage Basket.

Dimensions: 2" diameter, 50" (127 cm) Long

Shipping Weight: 7 lbs (3.2 kg)



Pole-Mount Brackets

60-131-003 aluminum

Two Brackets for mounting LX, 200, 400 Series, Extenders, on vertical 2" Round Pole

Shipping Weight: 2 lbs (.9 kg)

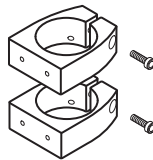

Pole-Mount Bracket

60-144-003 aluminum

Use this single bracket to mount CPU Holders, Wire Storage Basket on vertical 2" Round Pole

Shipping Weight: 2 lbs (.9 kg)

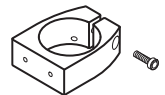

Split Pole-Mount Bracket

60-199-003 aluminum

Split Pole-Mount Bracket (1 Bracket) - use with Pole having no open end to mount LX, 200, 400 Series, Extenders, CPU Holders, and Wire Storage Basket on vertical 2" Round Pole

Shipping Weight: 2 lbs (.9 kg)

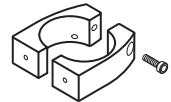

Pole-Mount Bracket Kit

97-094-099 grey

Pole-Mount Bracket Kit (1 Bracket, 1 Plate) - use on 2" Pole to mount 100 Series pivots.

Shipping Weight: 2 lbs (.9 kg)

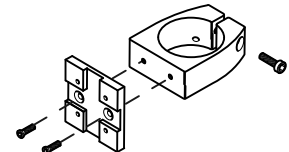

Command Post - Components

Command Post

20-076-100 grey

Command Post gives you the flexibility to mount one or more computer systems to a floor or ceiling using little or no floor space*. Constructed from heavy-duty 11-gauge steel for long-lasting durability.

Dimensions: 80" high x 3" wide x 3" deep (2032 x 76 x 76 mm)

Shipping Weight: 32 lbs (14.5 kg)

* To mount to horizontal surface, order Command Post Base, 60-360-100 separately.

3" x 3" Post Mounting Solutions Bracket

60-154-100 grey

Mounts Sit-Stand Combo Arms, CPU Holders, Extender Arm* to 3"x3" Command Post

Shipping Weight: 1 lbs (.5 kg)

* You need 2 of these when attaching Extender Arm.

3" x 3" Post Bracket

60-366-100 grey

Mounts 100, 200, 400 Series Arms, LX Arms, Universal CPU, Neo-Flex products to 3"x3" Command Post

3" x 3" Post Peripheral Bracket

60-158-100 grey

Mounts CPU Holder products to 3"x3" Command Post



Base

60-360-100 grey

Attaches command post to horizontal surface.*

Shipping Weight: 1 lbs (.5 kg)

* If mounting base to concrete surface, the hardware kit for concrete, 90-018-100 should be ordered, see below.

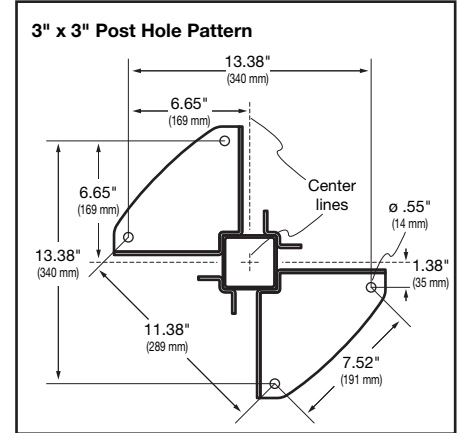
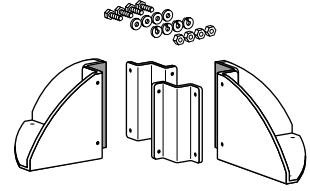

Hardware Kit for Concrete

90-018 grey

The Kit contains 4 stud anchors for attaching the command post base, 60-360-100, to a concrete surface.

Shipping Weight: 1 lbs (.5 kg)

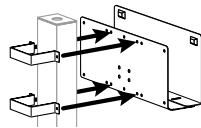
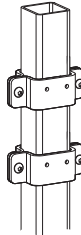
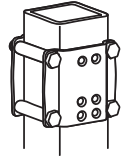

Command Post Configuration Examples

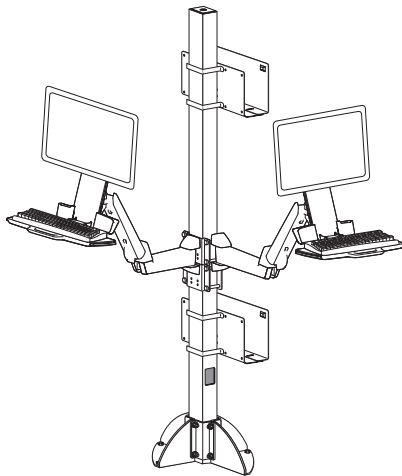

Ceiling Mount

Example System 2: Order these components

(2) 45-266-026, Available with black head-assembly only, polished aluminum, Sit-Stand Combo Arm

(2) 45-261-026, polished aluminum, Extender Arm

20-076-100, grey, 80" x 3" x 3" (2030 x 75 x 75 mm) Post

60-360-100, grey, 7" x 17" x 17" (178 x 432 x 432 mm) base

90-018, hardware kit for concrete surface attachment

(2) 60-154-100, grey, HD Arm Post Bracket (allows for single or dual back-to-back mounting)

(2) 97-468-202, Vertical Universal CPU Holders

(2) 60-158-100, grey, CPU Holder Brackets

Wrist rests, mouse holders, mouse pads are also available

Wallmounts



Extender Arm 45-261-026

Accessories



Part Number: 97-565

Description: SV40 Basket and Handle Kit, single t-slot channel attachment (white, grey)

Includes handle, basket, mounting hardware

Internal dimensions of basket: 5.875"H x 13.25"W x 3.125"D (149 x 337 x 79 mm)

Durable plastic and metal design

Designed for the StyleView EMR Laptop Cart, SV40. Also compatible with other StyleView 41/42-Series EMR Carts, which come standard with this basket and handle

Attaches to rear of cart using a single t-slot channel bracket

Weight Capacity: 5 lbs (2.3 kg)

Shipping Dimensions: 16.5" x 6.3" x 8.2" (420 x 160 x 209 mm)

Shipping Weight: 4 lbs (1.8 kg)

Warranty: Five (5) years



Part Number: 97-576-053

Description: SV32 PHD Triple Drawer (white/grey)

Includes auto-locking triple drawer accessory, mounting hardware

Only add this accessory drawer to powered SV32 PHD carts (attaches to cart underneath existing drawer). This drawer accessory will not communicate with SV31 PHD carts or legacy SV31, SV32 carts

A maximum of 2 drawer modules per cart is recommended

One cable connects to existing drawer controller

Durable, easy-to-clean exterior composed of aluminum, high-grade plastic and zinc-plated steel

Product Dimensions: 17.75"L x 13.5"W x 5"H (451 x 343 x 127 mm)

Shipping Dimensions: 21.7" x 19.4" x 7.9" (55 x 49 x 20 cm)

Shipping Weight: 16 lbs (7.3 kg)

Warranty: Five (5) years excepting electrical components, which carry a warranty of two (2) years

Accessories



Part Number: 97-703

Description: SV 3-Outlet Power Strip, IEC

Power strip head is located in the cart's storage area allowing computer equipment to be plugged in there rather than in the base

The power strip attaches directly to the cart's power module via IEC connection

Length = 72" (28 cm)

Compliant with North American power standards

UL listed

Shipping Dimensions: 8" x 5" x 3" (200 x 120 x 75 mm)

Shipping Weight: 1 lbs (.5 kg)

Warranty: One (1) year



Part Number: 97-702

Description: K-Slot Lock Kit

Includes lock, cable, Allen wrench, 2 keys

Compatible with notebooks, displays, thin clients or CPUs that include a K-slot attachment location

Length = 24" (9.5 cm)

Shipping Dimensions: 6" x 6" x 1" (152 x 102 x 25 mm)

Shipping Weight: 1 lbs (.5 kg)

Warranty: Five (5) years



Part Number: 97-618

Description: One (1) 40 Ah, 12 V DC, Lithium Iron Phosphate (LiFe) battery

Compatible with StyleView EMR Carts with LiFe Power only

40 Amp Hour

VAC = 120V/60Hz

Shipping Dimensions: 9.5"W x 11"H x 7"L (241 x 279 x 158 mm)

Shipping Weight: 18 lbs (8 kg)

Warranty: See manufacturer's warranty document linked below



Part Number: 97-505

Description: Foam Wrist Rest Accessory Kit (grey)

Includes wrist rest, adhesive tape, alcohol wipe

Rest Dimensions: 16.5"L x 1.4"W x .9"H (420 x 35 x 23 mm)

Ships with Ergotron products that include a wrist rest

Shipping Dimensions: 18" x 3" x 1.25" (457 x 76 x 32 mm)

Shipping Weight: 1 lbs (.5 kg)

Warranty: One (1) year



Part Number: 97-533

Description: Wrist Rest, antimicrobial (black)

Includes wrist rest, adhesive tape, alcohol wipe

Product Dimensions: 16.5"L x 1.4"W x .9"H (420 x 35 x 23 mm)

Shipping Dimensions: 18" x 3" x 1.25" (457 x 76 x 32 mm)

Shipping Weight: 1 lbs (.5 kg)

Warranty: One (1) year

Accessories



Tech Specs

Screen	Capacity	Lift	Tilt	Pan	Rotation	VESA
—	1.5 lbs .7 kg	—	—	—	—	—

Part Number: 97-566

Description: Wall Mount Scanner Holder (black)

Includes scanner holder, mounting hardware

Durable, easy-to-clean exterior composed of high-grade plastic

Compatible with most barcode scanners

Footprint on wall: 1.75" x 3.5" (45 x 89 mm)

Shipping Dimensions: 4.5" x 4.24" x 3.5" (114 x 108 x 89 mm)

Shipping Weight: .5 lbs (.23 kg)

Warranty: Five (5) years



Part Number: 97-543-207

Description: Wire Scanner Holder for Ergotron carts t-slot channel

Includes holder, t-slot attachment hardware

A scanner holder is included with all StyleView Carts. This accessory can be added to a StyleView to hold a second scanner

Mounts to the t-slot channel on center column of the cart

May be mounted facing right or left

Durable, easy-to-clean steel/aluminum construction

Shipping Dimensions: 3.5" x 3" x 5.5" (86 x 68 x 138 mm)

Shipping Weight: 2 lbs (.9 kg)

Warranty: Five (5) years



Tech Specs

Screen	Capacity	Lift	Tilt	Pan	Rotation	VESA
—	10 lbs* 4.5 kg	—	—	—	—	MIS-D

Part Number: 97-527-009

Description: VESA CPU Mount for Neo-Flex Mobile MediaCenter carts (black)

Not compatible with carts shipped prior to October, 2009

To verify your cart's compatibility, check its date stamp, which can be found on the box label and on the product ID label (located under the top cover of the cart's post). It should read "K34" or later (the letter represents the year of manufacture; "K" = 2009, "L" = 2010, etc.)

Includes VESA-mount quick-release kit, CPU bracket, cable tray, attachment bracket

Mounting Options: Attaches to cart behind large display bracket; VESA-CPU attaches with 4 screws to quick-release bracket

CPU must have either a VESA MIS-D 75 x 75 mm or 100 x 100 mm mounting hole pattern

Quick-release feature can be disabled for theft deterrence

* Maximum CPU size (W x H x D) = 13.5" x 10" x 2.6" (34.3 x 25.4 x 6.6 cm), up to 7 lbs (3.2 kg). Power brick/cables maximum weight = 3 lbs (1.4 kg)

Durable, easy-to-clean exterior composed of aluminum, high-grade plastic and powder-coated painted steel

Shipping Dimensions: 16.2" x 11.8" x 6.5" (41 x 30 x 25 cm)

Shipping Weight: 5 lbs (2.3 kg)

Warranty: Five (5) years

Accessories

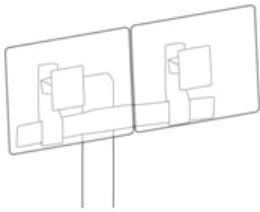

Tech Specs

Screen	Capacity	Lift	Tilt	Pan	Rotation	VESA
≤ 22"*	12–28 lbs† 5.4–12.7 kg	–	30°	–	360° P/L	MIS-D

Part Number: 97-615

Description: Tall-User Kit for WorkFit Dual

Includes two (2) single monitor pivots, two (2) riser brackets, installation hardware

* Maximum outside width of display is 21.25" (54 cm) when displays are 2" (5 cm) thick. This is typically the horizontal dimension of a 22"-diagonal screen-size monitor. Actual allowable width of displays will vary slightly depending on display thickness

† Weight Capacity: 6–14 lbs (2.7–6.3 kg) per display, 12–28 lbs (5.5–12.7 kg) combined

Mounting Standards: VESA FDMI MIS-D, 100/75, C (hole pattern: 100 x 100 mm & 75 x 75 mm)

Warranty: Five (5) years

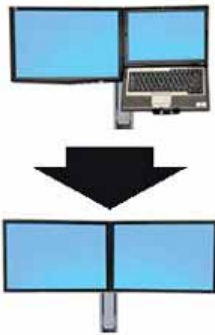

Tech Specs

Screen	Capacity	Lift	Tilt	Pan	Rotation	VESA
≤ 22"*	†	–	–	–	360° P/L	MIS-D

Part Number: 97-616

Description: WorkFit Convert-to-Dual Kit from LCD & Laptop, for WorkFit-S, WorkFit-C or WorkFit-A

Only compatible with part numbers 33-340-200, 24-213-085, 33-348-200, 24-195-055, 24-258-026, 24-273-026

* Maximum outside width of display is 21.25" (54 cm) when displays are 2" (5 cm) thick. This is typically the horizontal dimension of a 22"-diagonal screen-size monitor. Actual allowable width of displays will vary slightly depending on display thickness

† Weight Capacity is contingent on the WorkFit platform to which the kit is added

Mounting Standards: VESA FDMI MIS-D, 100/75, C (hole pattern: 100 x 100 mm & 75 x 75 mm)

Shipping Dimensions: 15" x 7" x 7" (380 x 180 x 180 mm)

Shipping Weight: 4 lbs (1.8 kg)

Warranty: Five (5) years

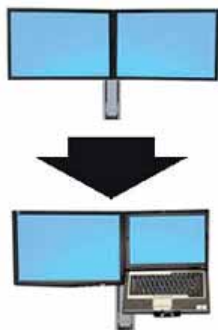

Tech Specs

Screen	Capacity	Lift	Tilt	Pan	Rotation	VESA
≤ 20"	*	–	30°	–	360° P/L	MIS-D

Part Number: 97-617

Description: WorkFit Convert-to-LCD & Laptop Kit from Dual Displays, for WorkFit-S, WorkFit-C or WorkFit-A

Only compatible with part numbers 33-341-200, 33-349-200, 24-214-085, 24-196-055, 24-257-026, 24-272-026

* Weight Capacity is contingent on the WorkFit platform to which the kit is added

Use laptop with a separate, external keyboard for proper ergonomics

Mounting Standards: VESA FDMI MIS-D, 100/75, C (hole pattern: 100 x 100 mm & 75 x 75 mm)

Shipping Dimensions: 19.25" x 14.25" x 6.25" (490 x 362 x 158 mm)

Shipping Weight: 6 lbs (2.7 kg)

Warranty: Five (5) years

Accessories

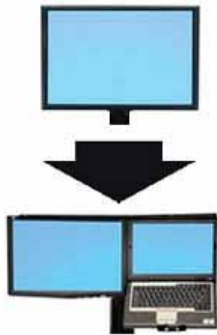

Tech Specs

Screen	Capacity	Lift	Tilt	Pan	Rotation	VESA
≤ 20"	*	—	30°	—	360° P/L	MIS-D

Part Number: 97-605

Description: WorkFit Convert-to-LCD & Laptop Kit from Single HD Display, for WorkFit-C or WorkFit-A
Only compatible with parts numbers 24-216-085, 24-275-026, 24-260-026. This kit is not compatible with any WorkFit-S products

* Weight Capacity is contingent on the WorkFit platform to which the kit is added

Use laptop with a separate, external keyboard for proper ergonomics

Mounting Standards: VESA FDMI MIS-D, 100/75, C (hole pattern: 100 × 100 mm & 75 × 75 mm)

Shipping Dimensions: 27" × 13.75" × 6.25" (685 × 348 × 158 mm)

Shipping Weight: 9 lbs (4.8 kg)

Warranty: Five (5) years

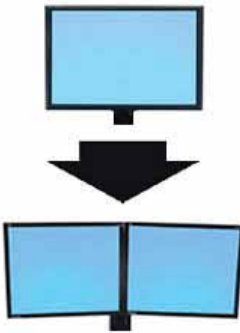

Tech Specs

Screen	Capacity	Lift	Tilt	Pan	Rotation	VESA
≤ 22"*	†	—	—	—	360° P/L	MIS-D

Part Number: 97-606

Description: WorkFit Convert-to-Dual Kit from Single HD Display, for WorkFit-C or WorkFit-A

Only compatible with part numbers 24-216-085, 24-275-026, 24-260-026. This kit is not compatible with any WorkFit-S products

* Maximum outside width of display is 21.25" (54 cm) when displays are 2" (5 cm) thick. This is typically the horizontal dimension of a 22"-diagonal screen-size monitor. Actual allowable width of displays will vary slightly depending on display thickness

† Weight Capacity is contingent on the WorkFit platform to which the kit is added

Mounting Standards: VESA FDMI MIS-D, 100/75, C (hole pattern: 100 × 100 mm & 75 × 75 mm)

Shipping Dimensions: 27.5" × 9.5" × 4.5" (699 × 239 × 118 mm)

Shipping Weight: 7 lbs (3.2 kg)

Warranty: Five (5) years



Tech Specs

Screen	Capacity	Lift	Tilt	Pan	Rotation	VESA
≤ 30"	16–28 lbs 7.3–12.7 kg	—	30°	—	360° P/L	MIS-D/E/F†

Part Number: 97-607

Description: WorkFit-C Convert-to-Single HD Display Kit from Dual or LCD & Laptop

Only compatible with part numbers 24-214-085 or 24-213-085

‡ Mounting Standards: VESA FDMI, MIS-D, 75/100, C (hole pattern = 100 × 100 mm & 75 × 75 mm); VESA FDMI, MIS-E, C (hole pattern = 200 × 100 mm); VESA FDMI, MIS-F, C (hole pattern = 200 × 200 mm). For displays that use a 400 × 200 mm hole pattern, the VESA Bracket Adaptor Kit (97-474) can be ordered separately

Shipping Dimensions: 5.5" × 5.5" × 4.75" (136 × 136 × 118 mm)

Shipping Weight: 3 lbs (1.4 kg)

Warranty: Five (5) years

Accessories

Wall Mount Bracket

Extra support for Wall Mount Arms

60-591-003 (Available North America, EMEA)

Fastener kit and wall plate that securely attaches Ergotron wall mounts to steel-stud constructed walls.

Compatible Ergotron Mounts: Neo-Flex HD Wall Mounts, LX Wall Mount Arms, 100 Series Pivots, 200 Series Wall Mounts, 400 Series Wall Mount Arms

Shipping Weight: 2.2 lbs (1 kg)

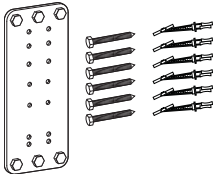

External Wall Track Kit for OSHPD

California Office of Statewide Health Planning And Development

This bracket must be ordered for use with wall track in any configuration where OSHPD compliance is required. Specific guidelines for wall type and allowable mounting solutions apply. Contact Ergotron Customer Care for full details.

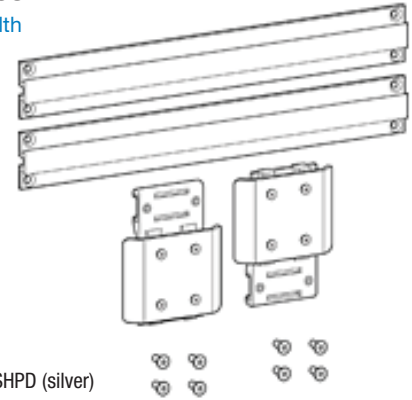

Part Number: 97-523-202

Description: External Wall Track Kit for OSHPD (silver)

Includes brackets for spanning 16" studs, hardware fasteners for mounting spanning brackets to the wall

OPA Pre-Approval number 2339-07

Approved products that can mount to an Ergotron Wall Track (excluding 10" Wall Track) installed on this External Mount include: StyleView HD Combo Arms (with or without extension), 200 Combo Arms, LX Wall Mount System, MX Wall Mount, 200 Arms, NF Swing Arm and NF Pivot. Contact Ergotron for a complete list of compatible products

Metal/woods studs must be 16" on center

These Office of Statewide Health Planning and Development (OSHPD) OPA Pre-Approved numbers are also compliant with the Japan Acceptance Criteria AC-156. AC-156 is the standard test for certification for international earthquake resistance as developed by the International Code Council

Shipping Weight: 19" x 8.5" x 3.25" (48.3 x 21.6 x 8.3 cm)

Shipping Weight: 4 lbs (1.8 kg)

Keyboard Trays, Laptop Trays & Accessories

Use the Keyboard/Mouse Tray in conjunction with 400 and 100 Series Keyboard Mounts. Use the Laptop Tray with any LCD arm or pivot with a 75 x 75 mm mounting hole pattern.

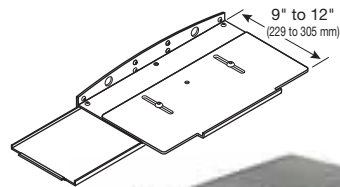

50-193-200



85-025-079



99-033-064 dark grey
99-033-085 black
99-033-099 grey



97-563-057

Part Number	Description	Dimensions W x D x H	Shipping Weight
Keyboard/Mouse Trays			
77-050-180, grey 77-050-200, black	Keyboard Tray w/ Sliding Mouse Tray and Wrist Rest Holder	17-1/2" x 9 to 12" x 2-1/2" (445 x 229 to 305 x 64 mm)	7 lbs (3.2 kg)
Laptop Trays			
50-193-200, black	LX Laptop Tray	(see below)	3 lbs (1.4 kg)
Wrist Rests & Mouse Accessories			
85-025-079, blue/white	Mouse Pad		1 lbs (.5 kg)
99-033-064, dark grey 99-033-064, black 99-033-064, grey	Mouse Holder		1 lbs (.5 kg)
Keyboard Holder, Articulating Mechanism			

Organize and route excess cables easily with Cable Channel

Part Number	Description	Dimensions L x W x D	Shipping Weight
97-563-057, grey*	Cable Management Kit, grey	11.25" x 1.75" x .75" (286 x 44 x 19 mm)	0.5 lbs (0.2 kg)

*Includes one (1) piece of 30" (76 cm) cable wrap, two (2) pieces of 11" (28 cm) cable management channel, two (2) adhesive strips, four (4), mounting screws, and four (4) hollow wall anchors.

Accessories

Display Interface Accessories



97-435-009,
Display Security
Bracket

Part Number	Description	Application	Shipping Weight
60-254-007, black	75 x 75 mm to 100 x 100 mm Conversion Plate Kit	Mounts 100 x 100 mm monitor to Ergotron mount with 75 x 75 mm interface	1 lbs (.5 kg)
97-435-009	VESA Adaptor Security Bracket	Works with Kensington security product to secure LCD to mounting solution.	3 oz (85 g)
97-501	Spacer Kit for Mounting to VESA Recess Monitors	Mounts to 75 x 75mm VESA Recess Monitors Includes: (1) spacer and (4) Phillips pan head M4 x 25 mm screws	0.13 lbs (0.06 kg)

Note: Fasteners to attach VESA FDMI compliant monitors and most Ergotron adapter interfaces are provided. However, user may need to supply own fasteners for some applications.

Interface Brackets for Motion Computing Tablet PCs



Interface Bracket for
Motion Computing C5
Tablet PC
60-588-200



Tablet PC Interfaces for Motion Computing

Part Number	Description	Application	Shipping Weight
60-588-200, black*	Motion Computing Interface Bracket for C5	see below	1.4 lbs (.6 kg)

* Includes interface bracket only. Tablet PC or FlexDock not included.

Part Number: 60-588-200

Description: Interface Bracket for Motion Computing C5 Tablet PC (black)

Includes: Bracket, mounting hardware, manual

Ergotron mount and Motion Computing C5 not included

Compatible with any LCD mount that uses a VESA MIS-D (75 x 75 mm) mounting hole pattern

The C5's docking station includes a 75 x 75 mm interface—where a mount's backward tilt is sufficient, the C5 can attach directly to any Ergotron mount with a VESA MIS-D interface

It is the perfect add-on to any StyleView or Neo-Flex Mobile WorkSpace Cart—dock the tablet at the rear of the cart while using an external LCD and keyboard. Also works well with FX30 and VL.

Shipping Dimensions: 6" x 6" x 4" (152 x 152 x 104 mm)

Shipping Weight: 1.4 lbs (.6 kg)

Warranty: Five (5) years

OSHPD VL9 External Wall Mount Kit

97-522-202

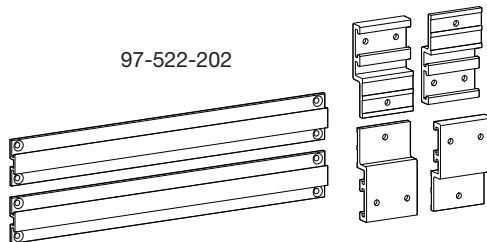

The OSHPD Mounting Kit for Vertical Lift can be attached in one of two ways, depending on the wall construction:

- 2x4" (51-102mm) Wood Studs: 16" on center
- Steel Studs: 20 gauge thick or thicker, 16" on center

Accessories

Cart Accessories

These optional accessories, including lockable medication drawers and utility shelf, are engineered to increase productivity and reduce errors.

SV = StyleView

NF1 = Neo-Flex Mobile WorkSpace

NF2 = Neo-Flex Mobile MediaCenter

NF3 = Neo-Flex WideView



WideView Camera Shelf Kit
97-500-055 **NF3**



NF MWS Laptop Security Bracket 97-465-057



StyleView Power System Batteries



SV21/SV22/NF1/NF2

Mouse Holder
99-033-064 dark grey



SV21/SV22/NF1/NF2/NF3

T-Slot Bracket
60-575-003

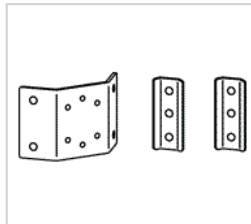

T-Slot Bracket Kit
60-587-207 aluminum
NF1/NF2/NF3



SV32

Autolock Drawer 97-462-053

SV21 Replacement Battery
55 Amp Hour, 12 Volt, Sealed Lead Acid
with connection harness 99-163-00

SV22 Replacement Battery Kit
55 Amp Hour, 12 Volt, Sealed Lead Acid
(available through Batteries Plus®)
99-166

SV32 Replacement Battery, 33 Ah
Sealed lead-acid 33 Ah battery
replaces batteries in StyleView
32-series 66 Ah Powered Carts.
Batteries must be purchased and
replaced in pairs (available through
Batteries Plus®) 97-479



MMC 660/800 mm Kit
97-489 **NF2**



NF MWS Laptop Security Bracket 97-465-057



NF Storage Basket
97-488-055 **NF1/NF3**

ERGOTRON®

© 2015 Ergotron, Inc. rev. 03/05/15 E-03-005 **Content is subject to change without notification**
Some products may not be available in some regions of the globe—visit our web site for more information

Americas Sales and Corporate Headquarters

St. Paul, MN USA
(800) 888-8458
+1-651-681-7600
www.ergotron.com
sales@ergotron.com

EMEA Sales

Amersfoort, The Netherlands
+31 33 45 45 600
www.ergotron.com
info.eu@ergotron.com

APAC Sales

Tokyo, Japan
www.ergotron.com
apaccustomerservice@ergotron.com

Worldwide OEM Sales

www.ergotron.com
info.oem@ergotron.com