

# Clarity MX46HD and MX55 LCD Video Wall Quick Start Guide



**PLANAR**<sup>TM</sup>

**Touchboards**

205 Westwood Ave, Long Branch, NJ 07740  
Phone: 866-94 BOARDS (26273) / (732)-222-1511  
Fax: (732)-222-7088 | E-mail: [sales@touchboards.com](mailto:sales@touchboards.com)



---

Copyright © 1 Feb 2013 by Planar Systems, Inc. All rights reserved.  
Contents of this publication may not be reproduced in any form without permission of Planar Systems, Inc.

### Trademark Credits

Windows™ is a trademark of Microsoft Corp.  
Planar's Big Picture™ is a trademark of Planar Systems, Inc.  
Planar's EasyAxis™ is a trademark of Planar Systems, Inc.  
All other names are trademarks or registered trademarks of their respective companies.

### Disclaimer

The information contained in this document is subject to change without notice. Planar Systems, Inc. makes no warranty of any kind with regard to this material. While every precaution has been taken in the preparation of this manual, the Company shall not be liable for errors or omissions contained herein or for incidental or consequential damages in connection with the furnishing, performance, or use of this material.

### Warranty and Service Plans

Planar warranty and service plans will help you maximize your investment by providing great support, display uptime, and performance optimization. From post-sale technical support to a full suite of depot services, our services are performed by trained Planar employees. When you purchase a Planar product, you get more than a display, you get the service and support you need to maximize your investment. To find the latest warranty and service information regarding your Planar product, please visit <http://www.planarcontrolroom.com/support>

### RoHS Compliance Statement

The Clarity Matrix Video Walls are fully RoHS compliant.

### ADA Compliance Statement

The Clarity Matrix Video Walls are compliant with the Americans with Disabilities Act.

Part Number: 020-1220-00A



# Table of Contents

- Introduction** .....1
- Safety Information .....2
  - Important Safety Instructions .....2
  - Important EMC Information.....3
  - European Union Disposal Information.....4
- Recommended Usage .....5
  - Burn-In Versus Temporary Image Retention .....5
  - Normal Use Thermal Guidelines.....6
- System Architecture.....7
- EasyAxis Mounts, General Description.....8
- Matrix Video Wall** .....9
- LCD Modules.....9
- LCD Mounting Structure..... 10
- Off-Board Equipment and Components..... 12
  - Quad Controller Module ..... 12
  - Power Supply Module ..... 13
- Installing a Clarity Matrix LCD Video Wall**..... 15
- Before You Begin..... 15
  - Tools/Equipment List ..... 15
  - Other Things You May Need ..... 15
  - Plan Your Installation ..... 16
  - Prepare Your Installation Location..... 18
- Installation Checklist ..... 19
- Unpacking and Checking Accessories ..... 19
  - Electronics Box ..... 20
  - LCD Module Box..... 21
  - Accessory Box(es)..... 22
  - Accessory Kit ..... 23
  - Optional Planar-Supplied Accessories ..... 25
- Regulatory Information**..... 27



# Introduction

The Clarity Matrix LCD Video Wall System uses cutting edge technology to provide a video wall solution using commercial-grade 46" and 55" full high definition (FHD) LCDs in a tiled application. The narrow-bezel results in a 5.7mm pixel-to-pixel gap between images on adjacent panels in a video wall. Each LCD module is an HDTV format with a 1920 x 1080 resolution. Each LCD module has a 3.6" installed depth and has an aspect ratio of 1.77 (16:9). It accepts a wide range of input DVI signals from VGA to UXGA.

The EasyAxis™ mounting system supports landscape and portrait orientation, free-standing wall deployment and flying wall applications. Because the panels are self-supporting, Clarity Matrix can support unlimited stacking height.



**Caution:** This manual is intended for use by qualified service persons and end users with experience installing LCD displays.

## Safety Information

This display was designed with safety in mind. If you don't heed the safety warnings and cautions, you could get hurt. The safety warnings are on stickers in various places in and on the display.

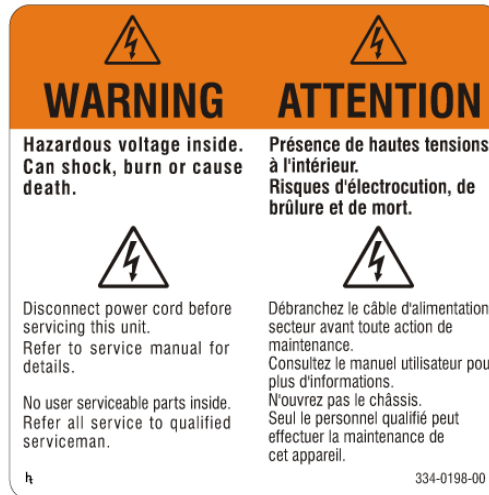

### Important Safety Instructions

- 1 Read these instructions.
- 2 Keep these instructions.
- 3 Heed all warnings.
- 4 Follow all instructions.
- 5 Do not use any of the Clarity Matrix LCD Video Wall products near water.
- 6 Clean the LCD screens with an LCD screen cleaner or LCD wipes.
- 7 Do not install near any heat sources such as radiators, heat registers, stoves or other apparatus (including amplifiers) that produce heat.
- 8 Do not defeat the safety purpose of the polarized or grounding type plug. A polarized plug has two blades with one wider than the other. A grounding type plug has two blades and a third grounding prong. The wide blade or the third prong is provided for your safety. When the provided plug does not fit into your outlet, consult an electrician for the replacement of the obsolete outlet.
- 9 Protect the power cord from being walked on or pinched particularly at plugs, convenience receptacles and the point where they exit from any of the Clarity Matrix LCD Video Wall products.



- 10 Only use the attachments/accessories specified by the manufacturer.
  - 11 Unplug all Clarity Matrix LCD Video Wall products during lightning storms or when unused for long periods of time.
  - 12 You must follow all National Electrical Code regulations. In addition, be aware of local codes and ordinances when installing your system.
  - 13 Refer all servicing to qualified service personnel. Servicing is required when any of the Clarity Matrix LCD Video Wall products have been damaged in any way, such as the AC power cord or plug is damaged, liquid has been spilled or objects have fallen into a product, the products have been exposed to rain or moisture, do not operate normally or have been dropped.
  - 14 Keep the packing material in case the equipment should ever need to be shipped.
  - 15 Wall mounts must be secure. The wall must be strong enough to hold all LCD modules, brackets and cables. Each MX46HD weighs about 39lbs (17.7kg) and each MX55 LCD module weighs about 50lbs (23kg). With protective optically bonded glass, the MX46HD LCD module weighs about 49lbs (22.2kg) and the MX55 LCD module weighs about 65lbs (29kg).
  - 16 Slight pressure on the LCD will cause distortion of the image. Heavier pressure will cause permanent damage. Clarity Matrix Video Walls should be mounted where viewers cannot touch the screen or insert small objects in the openings that will create hazards by contacting bare conductive parts.
- Caution:** The front polarizer is soft and subject to scratches from sharp objects.
- 17 The polarizer is a thin sheet of film laminated to the outside layer of glass on the LCD screen. Take care when handling items near the screen.

**Caution:** This product contains a lithium battery. There is a risk of explosion if the battery is replaced by an incorrect type. Dispose of the battery according to the instructions on the next page.

## Important EMC Information

In order to meet Electromagnetic Compatibility (EMC requirements), the installer will need to add one clip on ferrite bead to the 24VDC power cable near each LCD.



# European Union Disposal Information

English

- Disposal of old Electrical & Electronic Equipment (Applicable throughout the European Union and other European countries with separate collection programs)

This symbol found on your product or on its packaging, indicates that this product should not be treated as household waste when you wish to dispose of it. Instead, it should be handed over to an applicable collection point for the recycling of electrical and electronic equipment. By ensuring this product is disposed of correctly, you will help prevent potential negative consequences to the environment and human health, which could otherwise be caused by inappropriate disposal of this product. The recycling of materials will help to conserve natural resources.



This symbol is only valid in the European Union. If you wish to discard this product, please contact your local authorities or dealer and ask for the correct method of disposal.

Español

- Deshecho de equipos eléctricos y electrónicos (aplicable a la Unión Europea y a otros países europeos con programas de reciclaje independientes)

La presencia de este símbolo en el propio producto o en su material de embalaje, indica que no se debe tratar como residuo doméstico cuando desee deshacerse de él. En su lugar, debe entregarlo en el punto limpio correspondiente de reciclaje de equipos eléctricos y electrónicos. Asegurándose de que este producto se desecha de forma correcta, ayudará a evitar posibles consecuencias negativas para la conservación del medioambiente y la salud humana, consecuencias que podrían darse si se deshecha del producto de forma inadecuada. El reciclado de materiales ayuda a conservar los recursos naturales.



Este símbolo solamente es válido en la Unión Europea. Si desea deshacerse de este producto, póngase en contacto con las autoridades locales o con su distribuidor y pida información sobre el método de disposición adecuado.

Português

- Eliminação de equipamentos eléctricos e electrónicos usados (aplicável na União Europeia e noutros países europeus com programas próprios de recolha destes equipamentos)

Este símbolo, colocado no produto ou na respectiva embalagem, indica que o produto não deve ser tratado como lixo doméstico aquando da sua eliminação. Em vez disso, deve ser entregue num ponto de recolha de equipamentos eléctricos e electrónicos para posterior reciclagem. Ao garantir a correcta eliminação deste produto, estará a evitar consequências potencialmente negativas tanto para o ambiente como para a saúde humana. A reciclagem de materiais ajuda a preservar os recursos naturais.



Este símbolo apenas é válido na União Europeia. Se quiser eliminar este produto, contacte as entidades locais ou o seu fornecedor para ficar a saber qual o método de eliminação correcto.

Svenska

- Avfall av förbrukad elektrisk och elektronisk utrustning (Tillämpbart i hela Europeiska unionen och andra europeiska länder med separata samlingsprogram)

Den här symbolen som finns på din produkt eller på dess förpackning påvisar att produkten inte ska behandlas som hushållsavfall när du vill slänga bort den. Istället ska den lämnas över till en lämplig uppsamlingspunkt för återvinning av elektriska och elektroniska utrustningar. Genom att tillförsäkra att den här produkten återvinns på ett riktigt sätt hjälper du till med att förhindra möjliga negativa konsekvenser för miljön och mänsklig hälsa. Det kan annars orsakas på grund av olämplig sophantering av den här produkten. Återvinning av material kommer att hjälpa till att bevara naturtillgångar.



Den här symbolen är endast giltig inom den Europeiska unionen. Om du vill slänga bort den här produkten ska du kontakta lokala myndigheter eller återförsäljare, och fråga efter lämplig avfallsmetod.

Français

- Mise au rebut des équipements électriques et électroniques usagés (Valable dans l'ensemble de l'Union Européenne ainsi que dans les pays européens disposant de programmes distincts de collecte des déchets)

Ce symbole appliqué sur votre produit ou sur son emballage indique que ce produit ne doit pas être traité comme un déchet ménager lorsque vous voulez le mettre au rebut. Il doit au contraire être remis à un site de collecte agréé pour le recyclage des équipements électriques et électroniques. En veillant à ce que ce produit soit mis au rebut de façon adéquate, vous contribuerez à prévenir les conséquences potentiellement négatives sur l'environnement et sur la santé humaine qui risqueraient de se produire en cas de mise au rebut inappropriée de ce produit. Le recyclage des matériaux contribuera également à économiser les ressources naturelles.



Ce symbole n'est valable que dans l'Union Européenne. Si vous souhaitez mettre ce produit au rebut, veuillez prendre contact avec les autorités locales ou avec votre revendeur et renseignez-vous sur la méthode de mise au rebut correcte.

Italiano

- Smaltimento delle attrezzature elettriche ed elettroniche usate (applicabile in tutta la Comunità Europea ed altri Paesi Europei che applicano programmi di raccolta differenziata)

Il simbolo trovato sul prodotto, o sulla sua confezione, indica che il prodotto non può essere trattato come i domestici quando è il momento di smaltirlo. Al contrario, deve essere consegnato ad un centro di raccolta specializzato nel riciclaggio di attrezzature elettriche ed elettroniche. Assicurando che il corretto smaltimento di questo prodotto, si aiuterà a prevenire potenziali conseguenze negative sull'ambiente e sulla salute umana, che possono essere provocate da uno scorretto smaltimento di questa attrezzatura. I materiali riciclati aiuteranno a conservare le risorse naturali.



Questo simbolo è valido solo nell'Unione Europea. Per smaltire questo prodotto, mettersi in contatto con le autorità locali - o con il rivenditore - e chiedere informazioni sul corretto metodo di smaltimento.

Polski

- Użycie zużytego sprzętu elektrycznego i elektronicznego (Dotyczy krajów Unii Europejskiej i innych krajów europejskich z oddzielnymi programami zbiórki odpadów)

Obecność tego symbolu na produkcie lub na opakowaniu z produktem oznacza, że tego produktu nie można wyrzucać razem z odpadkami domowymi. Należy go przekazać do punktu zbiórki w celu poddania recyklingowi podzespół elektrycznych i elektronicznych. Usunięcie tego produktu w prawidłowy sposób, pomoże w zabezpieczeniu przed negatywnym wpływem odpadów na środowisko i zdrowie ludzi, powodowanym przez niewłaściwe usuwanie produktu. Przetwarzanie materiałów pomaga w zachowaniu zasobów naturalnych.



Ten symbol obowiązuje wyłącznie w krajach Unii Europejskiej. Informacje dotyczące prawidłowej metody usunięcia tego produktu, można uzyskać u władz lokalnych lub u dostawcy.

Suomi

- Vanhjojen sähkö- ja elektroniikkalaitteiden hävittäminen (Soveltuva kaikilla Euroopan unionin alueella, sekä muissa Euroopan maissa, joilla on erilliset keräysohjelmat)

Jos tuotteessa tai sen pakkauksessa on tämä symboli, sitä ei pidä hävittääessä käsitellä tavallisena kotitalousjätteenä, vaan se kuuluu toimittaa sähkö- ja elektroniikkalaitteiden kierrätyspisteeseen. Varmistamalla, että tämä tuote hävitetään asiaankuululla tavalla autat estämään mahdollisia ympäristölle ja ihmisille kovia negatiivisia seuraamuksia, joita sen vääränlainen hävittäminen voi aiheuttaa. Materiaalien kierrättäminen auttaa säilyttämään luonnonvarjoja.



Tämä symboli on voimassa ainoastaan Euroopan unionin alueella. Jos haluat hävittää tämän tuotteen, ota yhteyttä paikallisiin viranomaisiin tai jälleenmyyjään ja tiedustele asiaankuuluvia hävittämistimenpiteitä.

Deutsch

- Entsorgung von elektrischen & elektronischen Altgeräten (geltend für die Europäische Gemeinschaft und andere europäische Länder mit separaten Sammelprogrammen)

Dieses Symbol, zu finden auf Ihrem Produkt oder dessen Verpackung, macht Sie darauf aufmerksam, dass dieses Produkt bei der Entsorgung nicht als Hausmüll behandelt werden darf. Statt dessen sollte es an eine Sammelstelle zum Recycling von elektrischen und elektronischen Altgeräten gegeben werden. Helfen Sie mit, potenziell schädliche Einflüsse auf Umwelt und Gesundheit, die durch eine unsachgemäße Entsorgung dieses Produktes entstehen können, zu vermeiden und entsorgen Sie dieses Produkt ordnungsgemäß. Recycling hilft, natürliche Rohstoffe einzusparen.



Dieses Symbol ist nur innerhalb der europäischen Gemeinschaft gültig. Wenn Sie dieses Produkt entsorgen möchten, wenden Sie sich bitte an Ihre örtliche Behörde und fragen Sie nach der ordnungsgemäßen Entsorgungsmethode.

Nederlands

- Verwijderen van oude elektrische en elektronische apparatuur (toepasselijk in de volledige Europese Unie en andere Europese landen met afzonderlijke programma's voor afvalverzameling)

Dit symbol dat op het product of zijn verpakking is aangebracht, geeft aan dat dit product niet mag worden behandeld als huishoudelijk afval als u het wilt wegwerpen. U moet het afgeven bij een specifiek verzamelpunt voor de recyclage van elektrische en elektronische apparatuur. Door te garanderen dat u dit product op de correcte manier wegwerpt, helpt u potentiële negatieve gevolgen voor het milieu en de menselijke gezondheid, die zouden kunnen worden veroorzaakt door een onrechtmatig wegwerpen van het product, te voorkomen. De recyclage van materialen helpt het behoud van natuurlijke bronnen.



Dit symbol is alleen geldig in de Europese Unie. Als u dit product wenst weg te gooien, dient u contact op te nemen met uw lokale instanties voor details over de gepaste methode voor afvalverwijdering.

## Recommended Usage

In order to get the most out of your LCD modules, use the following recommended guidelines to optimize the display.

### Burn-In Versus Temporary Image Retention

Burn-in causes the screen to retain an image essentially forever, with little or no way to correct the problem. Under normal use, an LCD module will not experience burn-in, as plasma displays do, nor will it retain images in any way.

Normal use of an LCD module is defined as displaying continuously changing video patterns or images. However, LCD modules can experience *temporary* image retention when recommended usage guidelines are not followed.

#### What is Temporary Image Retention?

Temporary image retention (TIR) can occur when a static image is displayed continuously for extended periods of time. An electrical charge differential may build up between the electrodes of the liquid crystal, which causes a negative-color video image (color-inverted and brightness-inverted version of the previous image) to be retained when a new image is displayed. This behavior is true for any LCD device from any LCD manufacturer.

TIR is not covered under warranty. See standard warranty terms and conditions for details. Here are some guidelines to help you avoid TIR:

- Use the LCD module to show a screen saver, moving images or still pictures that change regularly. When using high-contrast images, reposition the images frequently.
- Turn off the LCD module when it is not in use. There are a few ways to do this automatically:
  - To use the LCD module's real-time clock, see "Setting the Clock/Scheduling an Event" on page 55.
  - To use your source computer's Power Options Properties, set up your computer to turn off the display when not in use. You also need to check the DPMS checkbox and set the DPMS DELAY box in the BACKLIGHT SETTINGS menu (MAIN MENU > ADVANCED OPTIONS > BACKLIGHT SETTINGS).
  - To use RS232 commands, see "RS232 Communication" on page 69.

**Caution:** For optimal performance, we suggest turning off the backlight power on the Matrix MX for four hours per day.

## Normal Use Thermal Guidelines

Normal use of the LCD module, Quad controller module and power supply module are defined as operating in the open air to prevent heat buildup, and without direct or indirect heat sources such as lighting fixtures, heating ducts, or direct sunlight that can cause the modules to experience high operating temperatures. For all modules, do not block fans or ventilation openings. If the LCD module will be installed in a recessed area with an LCD surround or enclosure, ensure adequate openings are applied for proper air flow and ventilation.

At 2000 meters or below, the maximum ambient operating temperature for the LCD module cannot be above 35° C nor below the minimum ambient operating temperature of 0° C. For the Quad controller module and power supply module, the maximum ambient operating temperature cannot be above 45° C nor below the minimum ambient operating temperature of 0° C. If one of these conditions exists, it is up to the installer to ensure that module placement is changed, thermal shielding is provided and/or additional ventilation is provided to keep the display within its nominal operating parameters.

### Cooling Requirements

For optimal performance, active cooling by the installer should be planned for when the ambient temperature at the top of the wall is predicted to be above the specified ambient temperature for the panel. Cooling may be done behind the displays and depending on the wall configuration, it may be helpful to place air ducts (AC) at every third display tall.

## System Architecture

The Clarity Matrix Video Wall has three main electronic components: the LCD module, power supply module and the Quad controller module. The LCD module has a removable interface board, which connects to the off-board power supply and Quad controller modules. Using external modules produces less heat and allows for reduced and/or easier service of the LCD module itself.



LCD module - front view

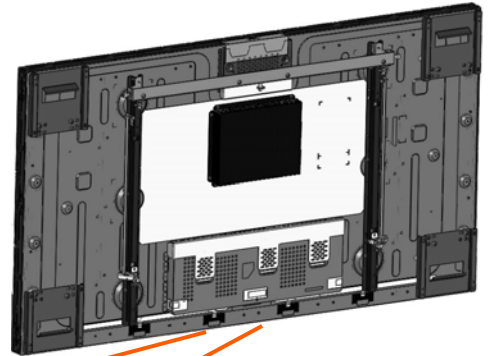

LCD module - rear view - MX55



Power supply module



Quad controller module

Some basic points to keep in mind:

- Each Quad controller module controls up to four LCDs
- Modules are linked together by RS485 cables
- The first processor in the A Quad controller module (A1) is the master processor
- The master processor takes in the input from the IR remote sensor and/or the host RS232 commands

The following example shows the connections for a basic video wall.

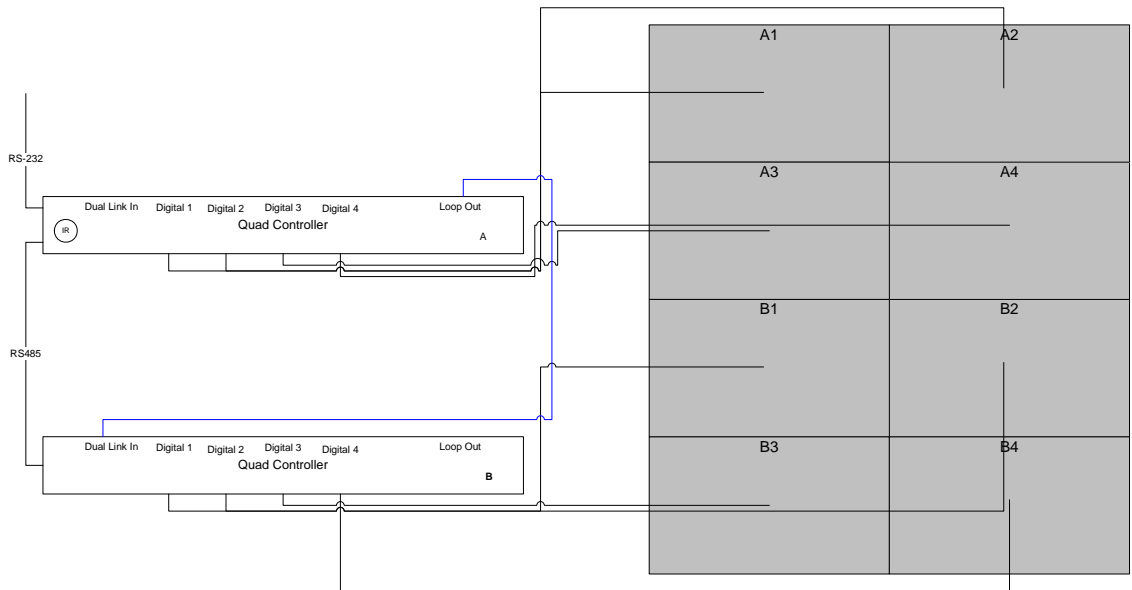

## EasyAxis Mounts, General Description

Planar-supplied mounts are used to secure the Clarity Matrix Video Wall for display. Follow these instructions carefully.

Keep in mind the following general installation guidelines:

- Prior to installation, make sure you know where all of the mounting points are located.
- Follow all safety precautions outlined in this manual.
- Verify the parts received with the list shown in this manual.

# Matrix Video Wall

The Clarity Matrix LCD Video Wall consists of several different modules. These are described in more detail on the following pages.

## LCD Modules

The LCD module is composed of a basic LCD without a cosmetic enclosure but with a mechanical subframe for mounting. The LCD module incorporates a simple interface board designed to distribute off-board power, video and control signals to the LCD module, keeping depth, weight, heat and points of potential failure to a minimum. The LCD blade-style module incorporates a bracket that is perfectly paired with the EasyAxis mount. The LCD module includes EasyAxis adjustment cams that facilitate precise six-axis alignment ensuring uniform, minimized image-to-image gap.

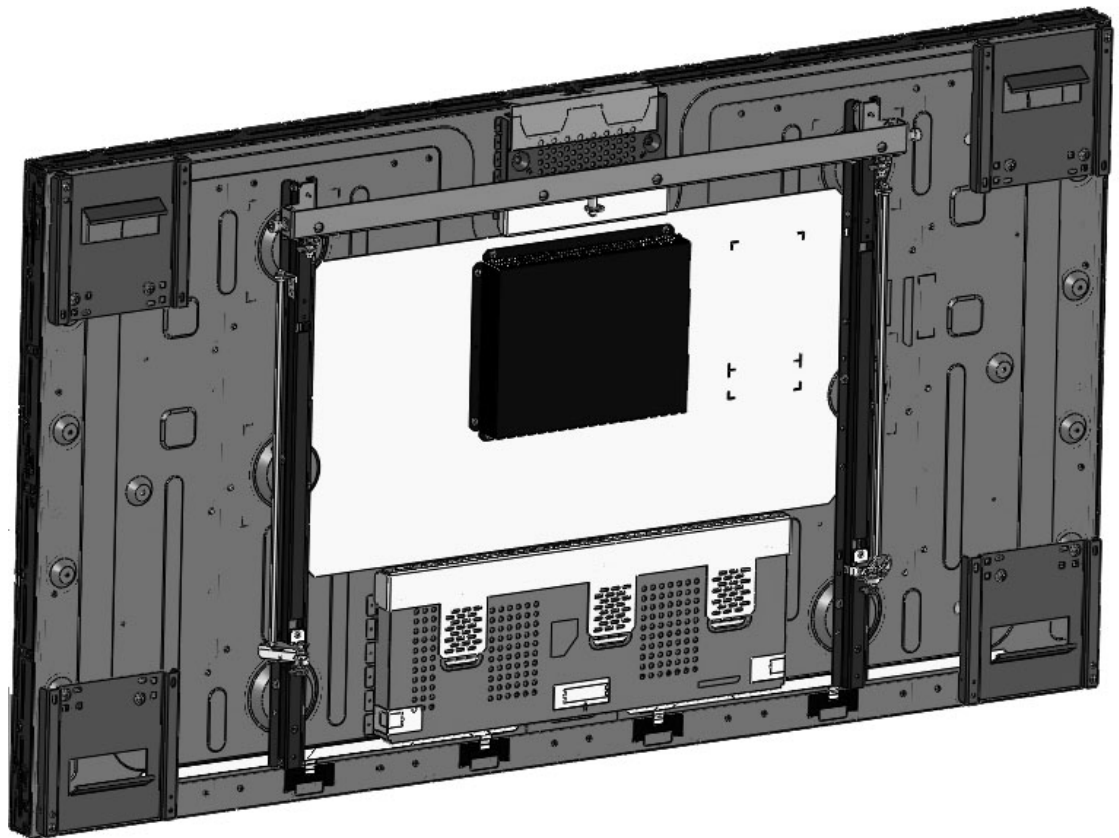

**Note:** This shows a rear picture of the MX55. The rear of MX46HD will look different.

## LCD Mounting Structure

The EasyAxis mounting system simplifies the task of installing and aligning the LCD modules while allowing for efficient in-wall service. EasyAxis is designed to be attached to a wall, used with optional free-standing bases or secured overhead in a flying configuration. When assembled, horizontal and vertical connection brackets ensure that each mount is perfectly spaced from its neighbor in the video wall. The mount system also incorporates a service mode to accommodate front and rear in-wall repair of any LCD module in the video wall.

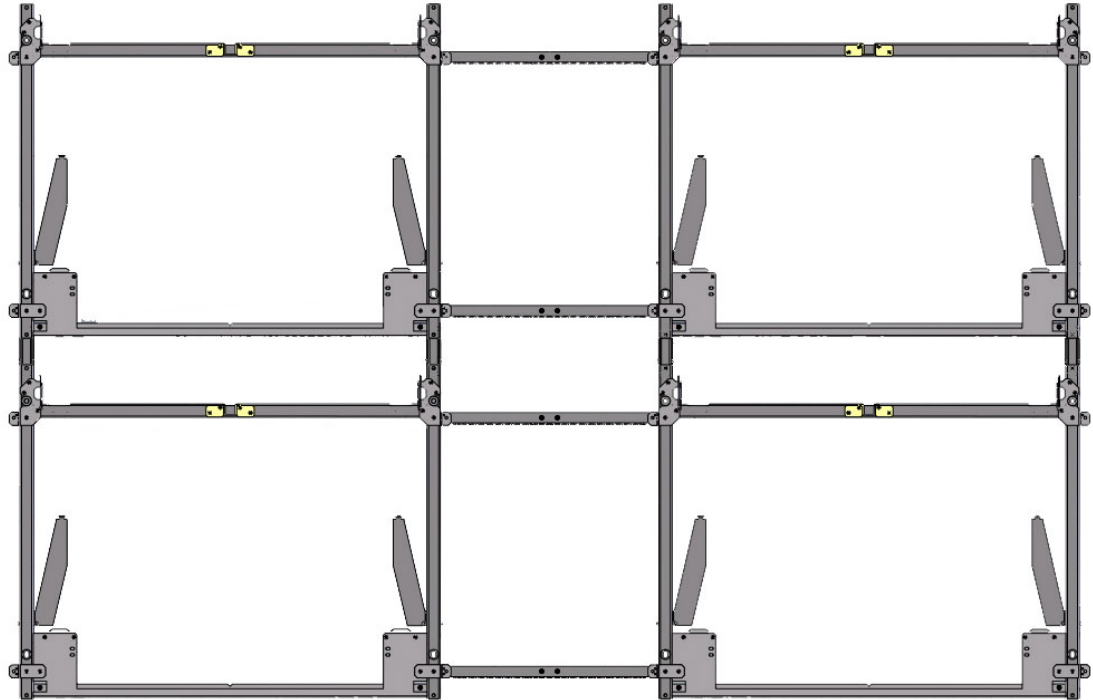



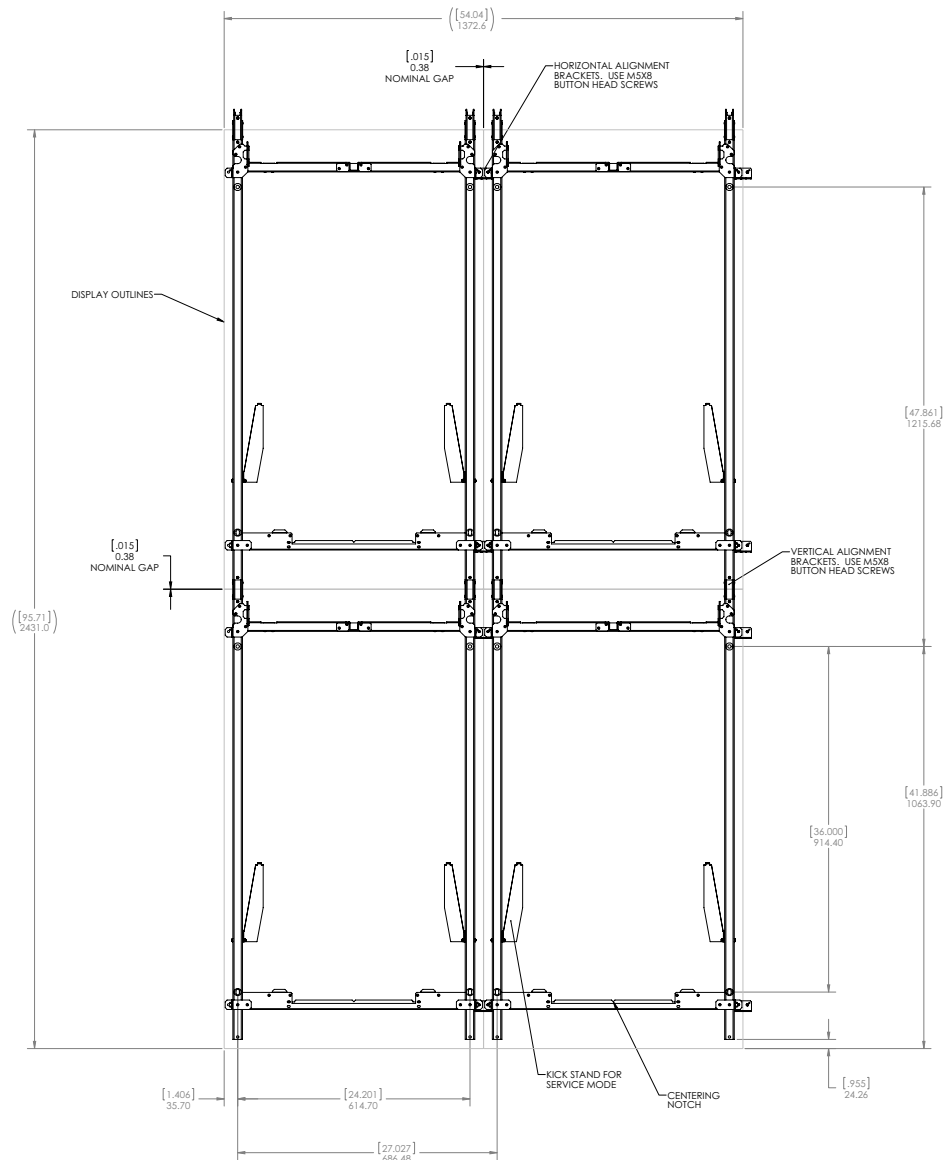

**Note:** This drawing shows portrait LCD mounts for the MX55. See "Matrix Dimensions" on page 173 for complete drawings of the MX55 and the MX46HD.

EasyAxis mounts are designed to facilitate the thinnest profile LCD video wall. The combination of the mount plus the Matrix LCD module's "blade" design results in video walls that measure 3.6 inches in depth, screen to wall.

## Off-Board Equipment and Components

To reduce heat issues and to make servicing of the video wall easier, the two main Matrix components are modules that are separate from the LCD module itself. The Quad controller modules and power supply modules can be housed in an equipment rack that is typically situated away from the video wall itself.

### Quad Controller Module

The Quad controller module contains four microprocessors, each of which manages the video information flowing to one LCD module. The Quad controller module routes up to four digital source inputs to the LCDs. For more information about what the different LEDs on the front of the Quad controller module mean, see "Quad Controller Status LEDs" on page 58.

#### Front View



#### Rear View

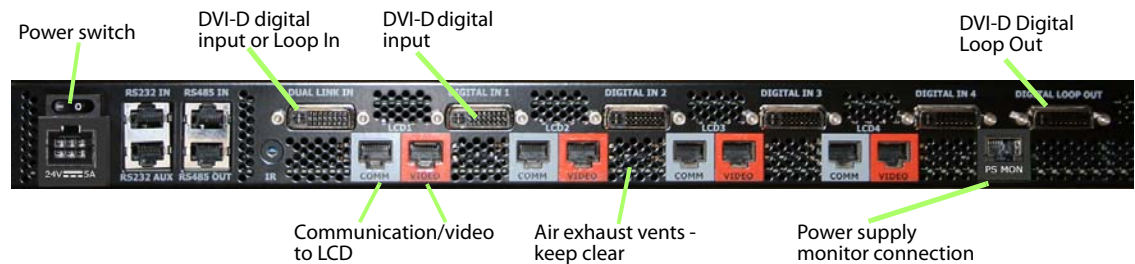

## Power Supply Module

The power supply module provides power for up to four LCDs and one Quad controller module.

### Front View



### Rear View

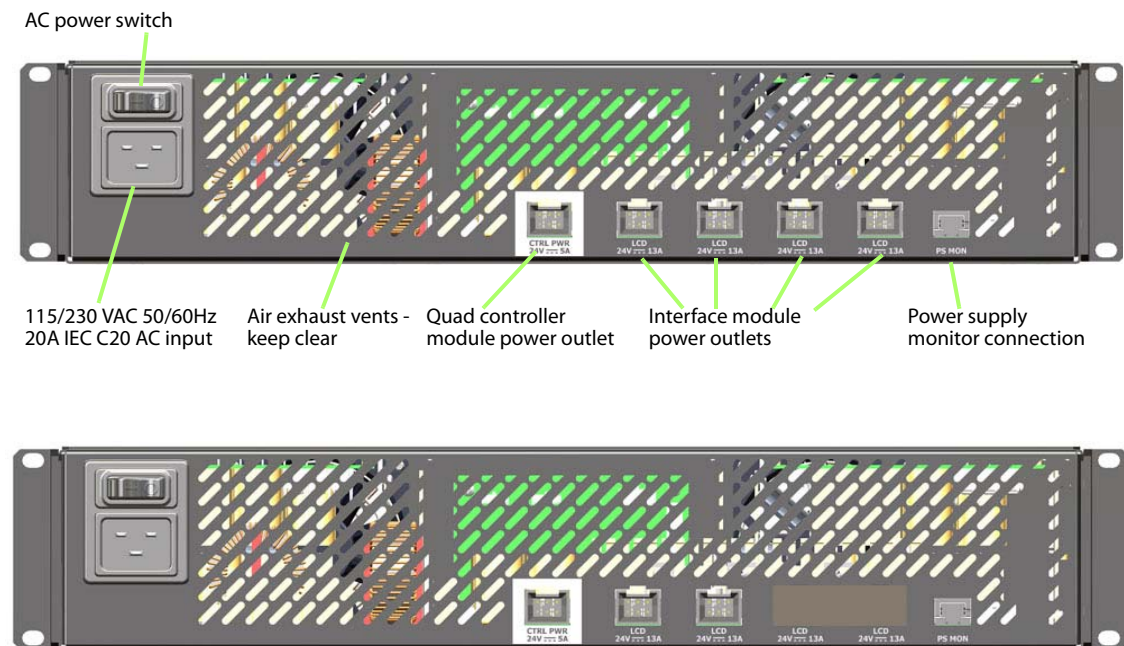

Depending on your configuration, these two outlets may be covered.



# Installing a Clarity Matrix LCD Video Wall

This section explains how to install a Clarity Matrix Video Wall. We suggest that you read this entire section before you attempt to install the wall.

## Before You Begin

Make sure you have all the items in the following lists before you begin unpacking and installing your Clarity Matrix Video Wall(s).

### Tools/Equipment List

Depending on your installation, you may need one or more of the following items:

- Drill and bits
- Nut drivers
- Pencil
- 3mm hex key
- M6 (#1/4-20) wrench
- String/string level
- Digital/laser level
- Ladders/lift
- Back brace
- Stud finder (if hanging LCD modules on a wall)
- Quad controller module address adjustment tool (included in your accessory kit)

### Other Things You May Need

- LCD screen cleaner or LCD wipes - available at most electronics stores
- At least two capable people to lift LCD modules into place

## Plan Your Installation

You should have a detailed plan of how the Clarity Matrix Video Wall is to be configured. The plan should include calculations for the following:

- Floor/wall load. Make sure the floor/wall is strong enough to support the weight of the whole Matrix system.
- To determine the total power consumption, you will need to calculate the size of the wall first.
- The minimum space above the top LCD row for installation and servicing clearance is 5". For passive cooling, it is recommended that a minimum of 8-10" of top clearance is provided. This can be reduced if the LCD array is actively cooled or open in the back and may need to be increased for very high walls.
- Access to both sides of the Quad controller modules and the power supply modules.
- Ventilation and cooling requirements. Although most of the heating elements are not in the LCD itself, it is still important that you have proper cooling and ventilation for the entire Clarity Matrix Video Wall and its off-board components.
- Power consumption of each individual component and the power consumption of the overall wall.

Component	Typical	Maximum	BTU Calculation
Power supply module	60W		60W x 3.42 = 205.2 BTU
Quad controller module	55W		55W x 3.42 = 188.1 BTU
MX46HD LCD module	115W	150W	115W x 3.42 = 393.3 BTU
MX55 LCD module	156W	212W	156W x 3.42 = 533.5 BTU

To calculate the overall power consumption of the wall, add the wattage of the power supply module, plus the Quad controller module, plus four LCDs per power supply module. For example, using the table above for a 2 x 2 video wall, you would have the following calculation:

- 60W (Power supply module) +
- 55W (Quad controller module) +
- 460W (115W x 4 MX46HD LCD modules) = **575W total power consumption**

**Note:** The above example assumes a typical installation with the backlight set at the default setting.

- Cable runs - Account for how long cable runs need to be and where they will be routed. The following table shows the maximum length allowed for power, data and video cables. The diagram below provides more detailed information about the supported cable lengths.

Cable Type	Maximum Length
Power cable	250 feet
COMM cable	500 feet
Video Cable	100 feet

**Note:** You can use cable extenders to a maximum of 500 feet using four extender boxes. When using cable extenders, all increments should be 100 feet or less.

## Supported Matrix Cable Lengths

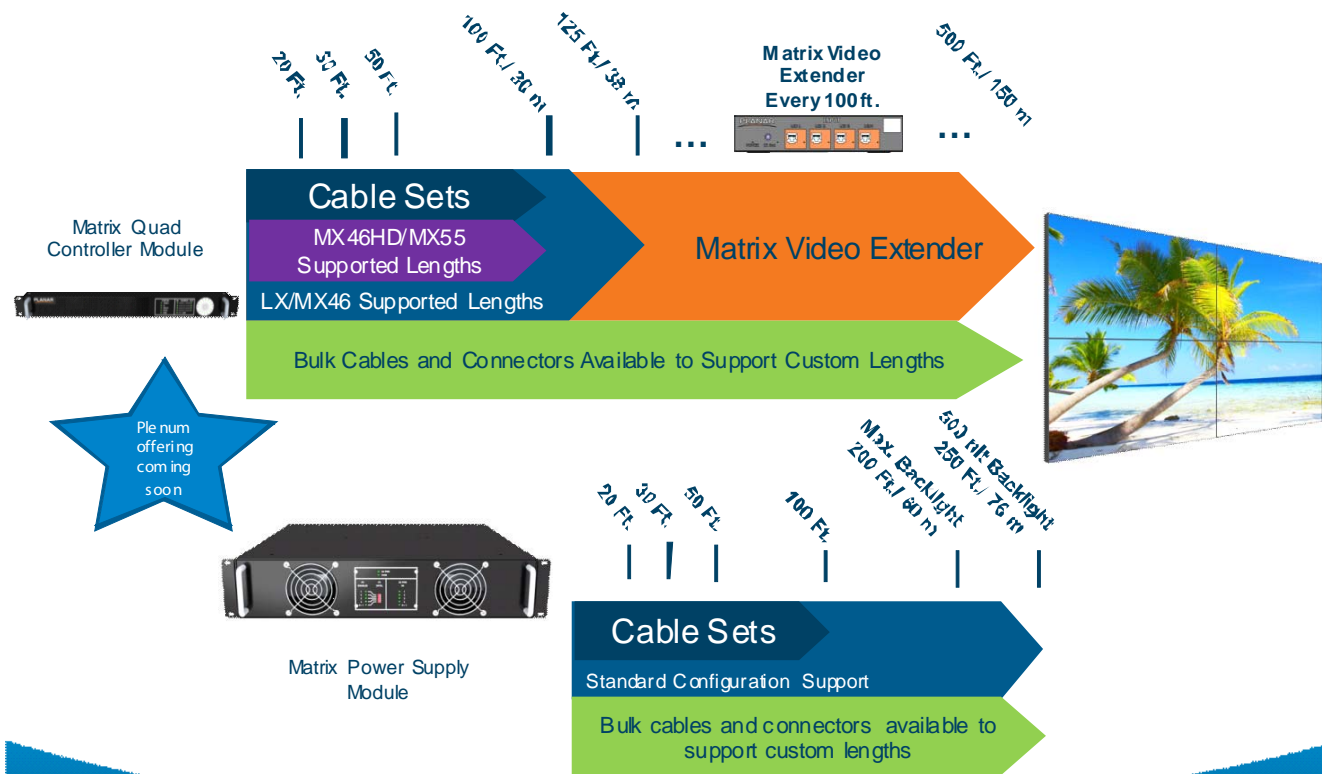

## Prepare Your Installation Location

You should have prepared the area where you will install the Clarity Matrix Video Wall. The mounting structures must be fully designed to accommodate the installation of the LCD modules. You must also make sure there is enough room for the off-board components and any equipment racks that might house these components.



## Installation Checklist

Use this quick checklist as a guide to ensure you have performed the installation steps in the correct order.

- 1 Unpack and install the LCD mount brackets.
- 2 Install Quad controller modules and power supply modules.
- 3 Run cables between LCD mount and brackets.
- 4 Install LCD modules.



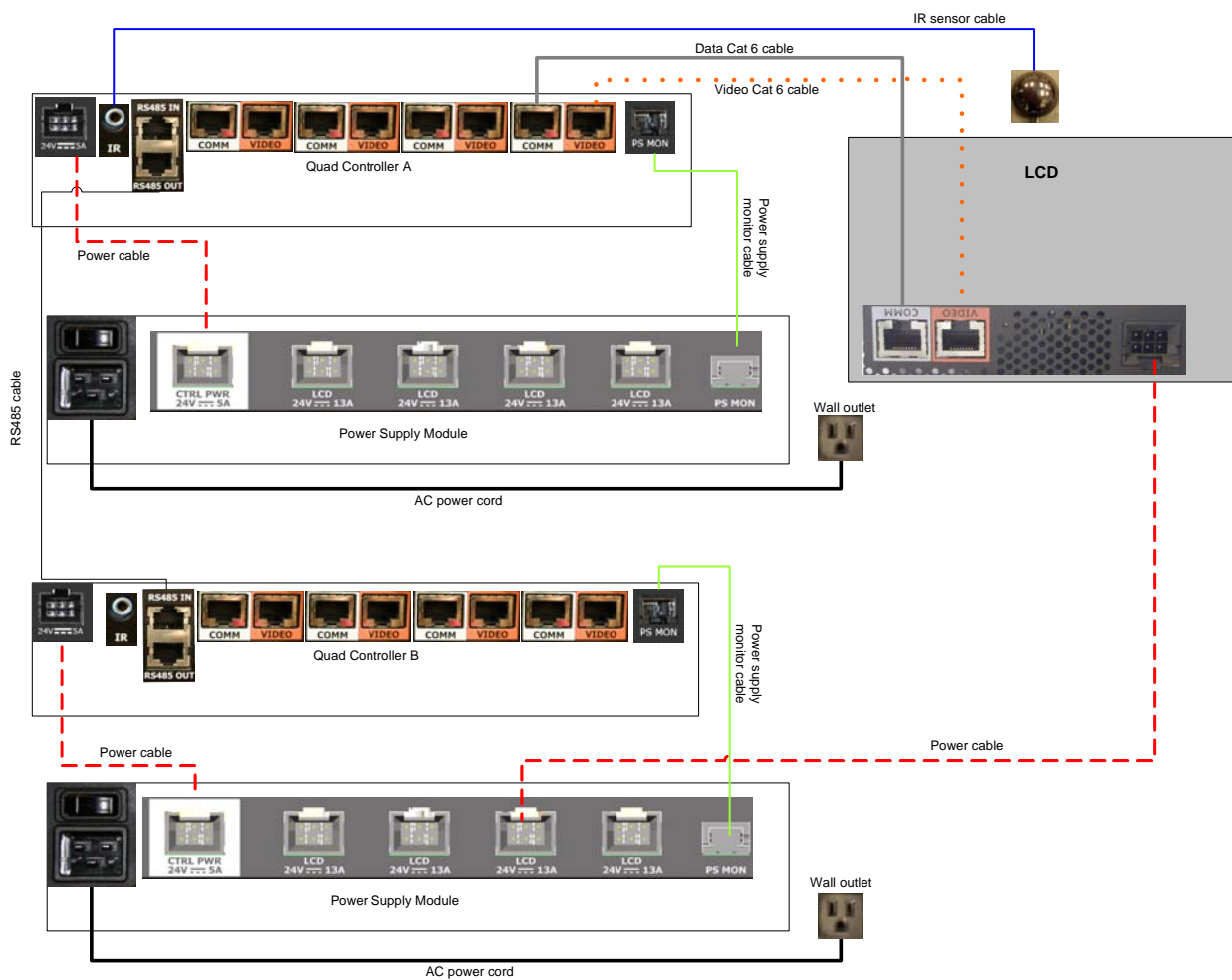

## Unpacking and Checking Accessories

The following diagram shows a basic connection of the different cables that connect to the different modules.



## Electronics Box



The following items are included in the electronics box.

Part	Description	Per Quad/Power Supply	Picture
Quad controller module	Routes up to four digital source images to the LCDs.	1	
Power supply module	Supplies power for up to four LCDs and one Quad controller module.	1	
Power cable (4ft)	Connects the power supply module to the Quad controller module.	1	
RJ45 to RJ45 patch cable (1m)	One cable connects the Quad controller module to the power supply module. The other cable connects one Quad controller module to another.	2	

**Note:** It is highly recommended that you use the cable label maker to identify each cable before it is installed.



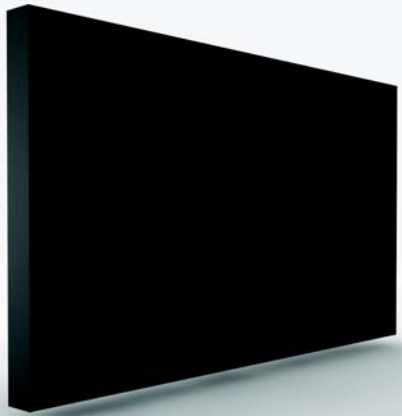

## LCD Module Box

The following items are included in the LCD module box.

<b>Part</b>	<b>Description</b>	<b>Picture</b>
LCD module	1 or 2 per box depending on your order.	 A photograph of a single, rectangular LCD module. The module is black and appears to be a thin, flat panel. It is shown from a slightly angled perspective, highlighting its depth.
LCD mount	1 or 2 per box depending on your order.	 A technical drawing of a metal LCD mount. The mount is a rectangular frame made of metal, with various adjustment points and mounting brackets. It is shown in a perspective view, highlighting its three-dimensional structure.

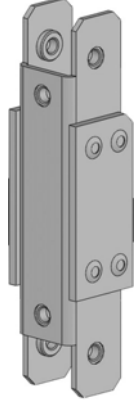

## Accessory Box(es)



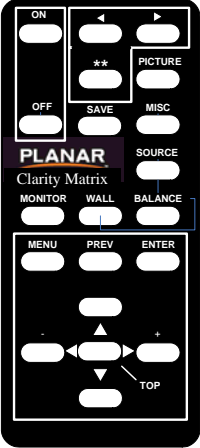

The following items are provided in the larger accessory box, which also contains the accessory kit box. The contents of this box are described below.

Part	Description	Number	Picture
Vertical bracket	Secures the LCD mount.	Depends on configuration requirements.	
Horizontal bracket (landscape)	Secures the landscape LCD mount.	Depends on configuration requirements.	
Horizontal bracket (portrait)	Secures the portrait LCD mount.	Depends on configuration requirements.	
AC power cable (3m)	Depending on your order, the cable will be for use in North America or Europe.	1 per power supply module	
Ferrite bead	Attached to each LCD to meet EMC requirements.	One per LCD panel.	

## Accessory Kit

The following items are included in the accessory kit, which is inside the larger accessory box.

Part	Description	Number Included	Picture
Gloves	Used to handle LCDs.	2 pairs	
Remote control	Used to control your on-screen menus.	2	
Remote control stand	Used to hold your remote control.	2	
Installation manual	Provides detailed setup and configuration information.	1	

Part	Description	Number Included	Picture
IR sensor	<p>Connects to Quad controller module A. Mount in a convenient location near your wall. Typically, this might be near the master (A1) display.</p> <p><b>Note:</b> Keep in mind that you need to point the remote towards where the IR sensor is mounted.</p>	1	
Cable labels	Used to help you identify each cable.	1 dispenser of 150 labels	
3mm assembly and alignment tool	Used to align modules.	2	
Quad controller module address adjustment tool	Used to set addresses of Quad controller modules.	2	

## Optional Planar-Supplied Accessories

Make sure you have the following optional customer-supplied items as needed to complete your installation:

- Curved brackets
- Stud adapter bracket
- WallNet
- Wall adapter bracket (see "Wall Adapter Bracket" on page 191)
- Floor stand
- Outer edge/rear cosmetic trim (see "Cosmetic Trim" on page 193)
- Dual link DVI-D cable
- DVI-D cables to go from the source to the Quad controller module
- RS232 cables to link an external controller to the Quad controller module
- Cat 6 -STP video and data cables - Length varies per wall depending on configuration requirements and your sales order.
- Power cable (20ft-100ft) - Connects the power supply module to the LCD. Length varies per wall depending on configuration requirements and your sales order.
- IR sensor extender cable (3m) - Used to extend from the wall to the Quad controller module.
- Matrix Video Extender Box - The video extender box allows you to extend the distance of the Quad controller modules to the LCD modules in 100 foot increments.
- DVI booster - When using the Dual Link In connector for looping between the Quad controller modules, it may be necessary to add a DVI booster to avoid having data glitches occur in some installations due to increased noise sensitivity on that connector.





# Regulatory Information

Manufacturer's Name: Planar Systems, Inc.  
Manufacturer's Address: 1195 NW Compton Drive  
Beaverton, OR 97006

Declares that the products Model Numbers: Clarity Video Matrix Wall

Conforms with the provisions of:

Council Directive 2004/108/EC on Electromagnetic Compatibility;

EN55022:2006+A7 Radiated and Conducted Emissions from IT Equipment

EN55024:1998 Immunity of IT Equipment

Including:	EN61000-4-2	Electrostatic Discharge
	EN61000-4-3	Radiated Immunity
	EN61000-4-4	Electrical Fast Transients
	EN61000-4-5	Line Surge
	EN61000-4-6	RF Conducted Susceptibility
	EN61000-4-8	Magnetic Field Immunity
	EN61000-4-11	Voltage Dips and Interrupts

And:	EN61000-3-2	Harmonic Current Emissions
	EN61000-3-3	Voltage fluctuations and Flicker

Council Directive 2006/95/EC on Low Voltage Equipment Safety:

EN60950:2006+A11 Safety of IT Equipment

The Technical Construction File required by this Directive is maintained at the corporate headquarters of Planar Systems, Inc., 1195 NW Compton Drive, Beaverton, OR 97006.

Note: This equipment has been tested and found to comply with the limits for a Class A digital device, pursuant to part 15 of the FCC Rules. These limits are designed to provide reasonable protection against harmful interference when the equipment is operated in a commercial environment. This equipment generates, uses, and can radiate radio frequency energy and, if not installed and used in accordance with the instruction manual, may cause harmful interference to radio communications. Operation of this equipment in a residential area is likely to cause harmful interference in which case the user will be required to correct the interference at his own expense.

Industry Canada (ICES-003): This Class A digital apparatus complies with Canadian ICES-003.

Cet appareil numérique de la classe A est conforme à la norme NMB-003 du Canada.

Any changes or modifications to the display not expressly approved by Planar could void the user's authority to operate this equipment.

Other Certifications

CISPR 22



# Index

---

## A

- accessories
  - accessory box contents, 22
  - accessory kit contents, 23
  - checking, 19
  - customer-supplied, 25
  - electronics box contents, 20
  - LCD module box contents, 21
  - optional, 25
- address adjustment tool, 24
- alignment tool, 24
- avoiding temporary image retention, 5

---

## B

- basic
  - connections example, 8
- before you begin
  - installing a wall, 15
  - tools/equipment list, 15
- brackets
  - horizontal, 22
  - vertical, 22

---

## C

- cables
  - AC power, 22
  - labels for identifying, 24
  - power, 20
  - power supply monitor, 20
- certifications, 27
- Clarity Matrix Video Wall, 1
  - system architecture, 7
- cleaning the LCD screen, 15
- conformity information, 27
- cooling requirements, 16
- customer-supplied accessories, 25

---

## D

- disposal information, 4

---

## E

- EasyAxis, 1, 21
  - description of mounts, 8
  - mounting structure, 9, 10
- equipment
  - list, 15
  - rack, 7
- europa union disposal information, 4

---

## G

- gloves for screen handling, 23

---

## H

- horizontal
  - bracket, 22

---

## I

- installation
  - checklist, 19
  - of video wall, 15
  - planning, 16
  - preparing your location, 18
  - space requirements, 16
- introduction, 1
- IR sensor, 24

---

## L

- labels
  - for identifying cables, 24
- LCD
  - wipes, 15

LCD module, 7, 9, 21  
    contents in box, 21  
    gloves for handling, 23  
    mounting structure, 10  
    weight, 3  
LCD mount, 9, 21

---

## M

manufacturer's address, 27  
Matrix video wall  
    LCD modules, 9

---

## N

normal use thermal guidelines, 6

---

## O

off-board equipment, 12  
optional  
    accessories, 25

---

## P

planning your installation, 16  
power cable, 20  
power supply module, 7, 13, 20  
    operation requirements, 16  
power supply monitor cable, 20  
preparing your installation location, 18

---

## Q

Quad controller module, 7, 12, 20  
    address adjustment tool, 24

---

## R

recommended usage, 5  
regulatory information, 27  
remote control, 23

---

## S

safety  
    information, 2  
    instructions, 2  
service plans, iii  
space requirements for installation, 16  
system  
    architecture, 7

---

## T

temperature  
    requirements for normal use, 6  
temporary image retention  
    avoiding, 5  
    definition, 5  
thermal guidelines, 6  
TIR *see temporary image retention*  
tools/equipment list, 15

---

## U

unpacking accessories, 19  
usage information, 5

---

## V

ventilation requirements, 16  
vertical  
    bracket, 22

---

## W

warranty information, iii  
weight  
    LCD module, 3

---