

TASCAM

D01278320A

SD-20M

Solid State Recorder

OWNER'S MANUAL

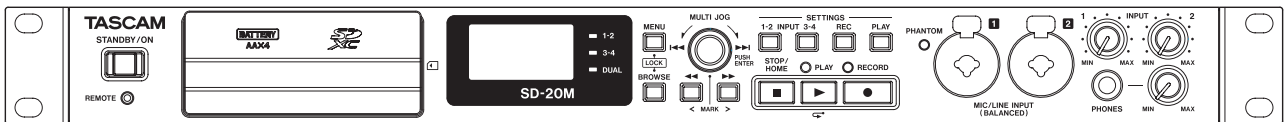

IMPORTANT SAFETY PRECAUTIONS

For U.S.A.

INFORMATION TO THE USER

This equipment has been tested and found to comply with the limits for a Class B digital device, pursuant to Part 15 of the FCC Rules. These limits are designed to provide reasonable protection against harmful interference in a residential installation. This equipment generates, uses, and can radiate radio frequency energy and, if not installed and used in accordance with the instruction manual, may cause harmful interference to radio communications. However, there is no guarantee that interference will not occur in a particular installation. If this equipment does cause harmful interference to radio or television reception, which can be determined by turning the equipment off and on, the user is encouraged to try to correct the interference by one or more of the following measures.

- a) Reorient or relocate the receiving antenna.
- b) Increase the separation between the equipment and receiver.
- c) Connect the equipment into an outlet on a circuit different from that to which the receiver is connected.
- d) Consult the dealer or an experienced radio/TV technician for help.

CAUTION

Changes or modifications to this equipment not expressly approved by TEAC CORPORATION for compliance could void the user's authority to operate this equipment.

For Canada

THIS CLASS B DIGITAL APPARATUS COMPLIES WITH CANADIAN ICES-003.

CET APPAREIL NUMERIQUE DE LA CLASSE B EST CONFORME A LA NORME NMB-003 DU CANADA.

DECLARATION OF CONFORMITY

We, TEAC EUROPE GmbH, Bahnstrasse 12, 65205 Wiesbaden-Erbenheim, Germany declare in own responsibility, the TEAC product described in this manual is in compliance with the corresponding technical standards.



Declaration of Conformity

Responsible party: TEAC AMERICA, INC.

Address: 1834 Gage Road, Montebello, California, U.S.A.



Telephone number: 1-323-726-0303

This device complies with Part 15 of the FCC Rules. Operation is subject to the following two conditions: (1) this device may not cause harmful interference, and (2) this device must accept any interference received, including interference that may cause undesired operation.

IMPORTANT SAFETY INSTRUCTIONS

- 1 Read these instructions.
- 2 Keep these instructions.
- 3 Heed all warnings.
- 4 Follow all instructions.
- 5 Do not use this apparatus near water.
- 6 Clean only with dry cloth.
- 7 Do not block any ventilation openings. Install in accordance with the manufacturer's instructions.
- 8 Do not install near any heat sources such as radiators, heat registers, stoves, or other apparatus (including amplifiers) that produce heat.
- 9 Do not defeat the safety purpose of the polarized or grounding-type plug. A polarized plug has two blades with one wider than the other. A grounding type plug has two blades and a third grounding prong. The wide blade or the third prong are provided for your safety. If the provided plug does not fit into your outlet, consult an electrician for replacement of the obsolete outlet.
- 10 Protect the power cord from being walked on or pinched particularly at plugs, convenience receptacles, and the point where they exit from the apparatus.
- 11 Only use attachments/accessories specified by the manufacturer.
- 12 Use only with the cart, stand, tripod, bracket, or table specified by the manufacturer, or sold with the apparatus. When a cart is used, use caution when moving the cart/apparatus combination to avoid injury from tip-over.



- 13 Unplug this apparatus during lightning storms or when unused for long periods of time.
- 14 Refer all servicing to qualified service personnel. Servicing is required when the apparatus has been damaged in any way, such as power-supply cord or plug is damaged, liquid has been spilled or objects have fallen into the apparatus, the apparatus has been exposed to rain or moisture, does not operate normally, or has been dropped.

- The apparatus draws nominal non-operating power from the AC outlet with its POWER or STANDBY/ON switch not in the ON position.
- The mains plug is used as the disconnect device, the disconnect device shall remain readily operable.
- Caution should be taken when using earphones or headphones with the product because excessive sound pressure (volume) from earphones or headphones can cause hearing loss.
- If you are experiencing problems with this product, contact TEAC for a service referral. Do not use the product until it has been repaired.

CAUTION

- Do not expose this apparatus to drips or splashes.
- Do not place any objects filled with liquids, such as vases, on the apparatus.
- Do not install this apparatus in a confined space such as a book case or similar unit.
- The apparatus should be located close enough to the AC outlet so that you can easily grasp the power cord plug at any time.
- If the product uses batteries (including a battery pack or installed batteries), they should not be exposed to sunshine, fire or excessive heat.
- CAUTION for products that use replaceable lithium batteries: there is danger of explosion if a battery is replaced with an incorrect type of battery. Replace only with the same or equivalent type.

WARNING

- Products with Class I construction are equipped with a power supply cord that has a grounding plug. The cord of such a product must be plugged into an AC outlet that has a protective grounding connection.

■ RACK-MOUNTING THE UNIT

Use the supplied rack-mounting kit to mount the unit in a standard 19-inch rack, as shown below.

Remove the feet of the unit before mounting.

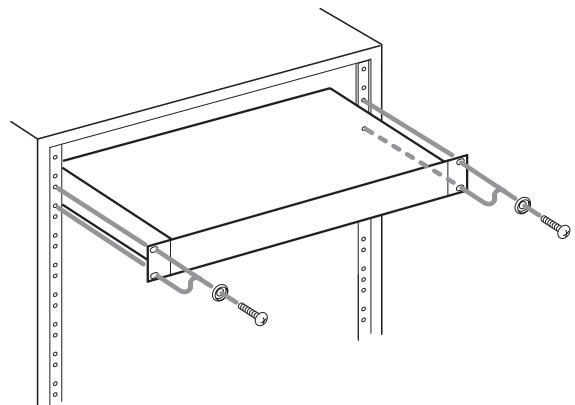

CAUTION

- Leave 1U of space above the unit for ventilation.
- Allow at least 10 cm (4 in) at the rear of the unit for ventilation.

Safety Information

CAUTIONS ABOUT BATTERIES

This product uses batteries. Misuse of batteries could cause a leak, rupture or other trouble. Always abide by the following precautions when using batteries.

- Never recharge non-rechargeable batteries. The batteries could rupture or leak, causing fire or injury.
- When installing batteries, pay attention to the polarity indications (plus/minus (+/-) orientation), and install them correctly in the battery compartment as indicated. Putting them in backward could make the batteries rupture or leak, causing fire, injury or stains around them.
- When you store or dispose batteries, isolate their terminals with insulation tape or something like that to prevent them from contacting other batteries or metallic objects.
- When throwing used batteries away, follow the disposal instructions indicated on the batteries and the local disposal laws.
- Do not use batteries other than those specified. Do not mix and use new and old batteries or different types of batteries together. The batteries could rupture or leak, causing fire, injury or stains around them.
- Do not carry or store batteries together with small metal objects. The batteries could short, causing leak, rupture or other trouble.
- Do not heat or disassemble batteries. Do not put them in fire or water. Batteries could rupture or leak, causing fire, injury or stains around them.
- If the battery fluid leaks, wipe away any fluid on the battery case before inserting new batteries. If the battery fluid gets in an eye, it could cause loss of eyesight. If fluid does enter an eye, wash it out thoroughly with clean water without rubbing the eye and then consult a doctor immediately. If the fluid gets on a person's body or clothing, it could cause skin injuries or burns. If this should happen, wash it off with clean water and then consult a doctor immediately.
- The unit power should be off when you install and replace batteries.
- Remove the batteries if you do not plan to use the unit for a long time. Batteries could rupture or leak, causing fire, injury or stains around them. If the battery fluid leaks, wipe away any fluid on the battery compartment before inserting new batteries.
- Do not disassemble a battery. The acid inside the battery could harm skin or clothing.

■ For European Customers

Disposal of electrical and electronic equipment

- (a) All electrical and electronic equipment should be disposed of separately from the municipal waste stream via designated collection facilities appointed by the government or the local authorities.
- (b) By disposing of the electrical and electronic equipment correctly, you will help save valuable resources and prevent any potential negative effects on human health and the environment.
- (c) Improper disposal of waste equipment can have serious effects on the environment and human health as a result of the presence of hazardous substances in electrical and electronic equipment.
- (d) The crossed out wheeled dust bin symbol indicates that electrical and electronic equipment must be collected and disposed of separately from household waste.
- (e) The return and collection systems are available to the end users. For more detailed information about disposal of old electrical and electronic equipment, please contact



your city office, waste disposal service or the shop where you purchased the equipment.

Disposal of batteries and/or accumulators

- (a) Waste batteries and/or accumulators should be disposed of separately from the municipal waste stream via designated collection facilities appointed by the government or the local authorities.
- (b) By disposing of waste batteries and/or accumulators correctly, you will help save valuable resources and prevent any potential negative effects on human health and the environment.
- (c) Improper disposal of waste batteries and/or accumulators can have serious effects on the environment and human health as a result of the presence of hazardous substances in batteries and/or accumulators.
- (d) The crossed out wheeled dust bin symbol indicates that batteries and/or accumulators must be collected and disposed of separately from household waste.

If the battery or accumulator contains more than the specified values of lead (Pb), mercury (Hg), and/or cadmium (Cd) defined in the Battery Directive (2006/66/EC), then the chemical symbols for lead (Pb), mercury (Hg) and/or cadmium (Cd) will be indicated beneath the crossed out wheeled dust bin symbol.
- (e) The return and collection systems are available to the end users. For more detailed information about disposal of waste batteries and/or accumulators, please contact your city office, waste disposal service or the shop where you purchased them.

IMPORTANT SAFETY PRECAUTIONS.....	2
IMPORTANT SAFETY INSTRUCTIONS	3
Safety Information	4
1 – Introduction	7
Features	7
Included items	7
Conventions used in this manual	7
Trademarks and copyrights.....	8
Precautions for placement and use.....	8
Beware of condensation.....	8
Cleaning the unit.....	8
About SD cards	9
Precautions for use	9
Using the TEAC Global Site.....	9
User registration.....	9
2 – Names and functions of parts	10
Front panel.....	10
Behind front cover	11
Rear panel.....	12
Home Screen	12
Recording screen	13
Menu structure	13
Basic Menu Screen operations.....	14
Menu operation procedures.....	14
Basic operation	14
3 – Preparation.....	15
Connecting other equipment	15
Powering the unit	16
Power sources	16
Using an AC adapter.....	16
Using AA batteries.....	16
Turning the power on and off (putting it in standby)	17
Turning the unit on.....	17
Turning the unit off (putting it in standby).....	17
Resume function	17
Setting the date and time	17
Inserting and removing SD cards.....	18
Inserting the card.....	18
Removing the card	18
SD card write protection switches	18
Preparing an SD card for use	18
Setting the key lock function.....	18
4 – Recording	19
Setting where to save files.....	19
Opening the INPUT 1-2 and INPUT 3-4 screens	19
Opening the REC SETTING screen	19
Setting the recording input sources	19
Adjusting the input level.....	20
Setting the low-cut filter	20
Setting phantom power.....	21
Using the Level Control Function.....	21
Setting the file format and sampling frequency	22
Recording (MONO/STEREO/4ch).....	22
Starting recording.....	22
File names when recording in MONO/STEREO.....	22
File names when recording 4 channels	22
Recording the moment before pushing RECORD (PRE REC)	23
Creating a new file while continuing to record (file splitting).....	23
Splitting files manually while recording.....	23
Splitting files automatically at set times while recording.....	23
Starting recording automatically (AUTO REC)	24
Setting the automatic recording function.....	24
Recording using the automatic recording function	24
Using mark functions.....	24
Adding marks manually to a recording	24
Adding marks automatically when recording	24
Moving to a mark position.....	24
Simultaneously recording two files at different input levels (DUAL REC)	25
Enabling dual recording	25
Starting dual recording.....	25
Dual recording file names.....	25
Recording duration	26
5 – Working with Folders and Files (BROWSE screen)	27
Opening the BROWSE screen	27
Screen navigation	27
Icons on the BROWSE screen.....	27
Folder operations.....	27
File operations	28
Creating new folders	28
Playlist	29
Adding files to the playlist	29
Editing the playlist	29
6 – Playback.....	30
Opening the PLAY SETTING screen.....	30
Playback area	30
Setting the playback area	30
Using the BROWSE screen to select the playback area folder (1)	30
Using the BROWSE screen to select the playback area folder (2)	30
Playing files	31
Pausing playback.....	31

Contents

Stopping playback.....	31
Rewinding and fast-forwarding (search)	31
Selecting files for playback (skipping).....	31
Changing the playback speed (VARI SPEED).....	31
Setting the play mode	32
Repeating playback.....	32
Jumping back a few seconds and replaying (jumpback playback)	32
7 – Settings and Information	33
Dividing a selected file manually (DIVIDE)	33
Setting the file name format	33
Setting the WORD item.....	33
Resetting the count (COUNT INIT)	33
Show media information	34
Restoring factory default settings	34
Formatting SD cards	34
Setting the output level	35
Make system settings.....	35
Setting the type of batteries.....	35
Set the automatic power saving function.....	35
Setting the backlight	35
Adjusting the display contrast.....	35
Viewing system information.....	35
8 – Using the REMOTE jack.....	36
Using a footswitch (TASCAM RC-3F).....	36
Setting up the footswitch	36
Using the footswitch.....	36
Using a remote control (TASCAM RC-10)	36
Setting up a wired remote control	36
Using the wired remote control.....	36
9 – Messages	37
10 – Troubleshooting	38
11 – Specifications	39
Ratings	39
Input/output ratings.....	39
Analog audio input and output ratings.....	39
Control input/output.....	39
Audio performance	39
General	39
Dimensional drawings	41

1 – Introduction

Thank you very much for purchasing the TASCAM SD-20M Solid State Recorder.

Before using this unit, read this owner's manual carefully so that you will be able to use it correctly and enjoy working with it for many years. After you have finished reading this manual, please keep it in a safe place for future reference.

You can also download this Owner's Manual from the TEAC Global Site (<http://teac-global.com/>).

Features

- Audio recorder that uses SD, SDHC and SDXC cards as recording media
- Simultaneous recording of up to 4 channels
- 44.1/48/96 kHz, 16/24-bit, linear PCM (WAV format) recording possible
- Broadcast Wave Format (BWF) supported as WAV recording format
- 32–320 kbps MP3 format recording possible (compatible with ID3 tag v2.4)
- Dual recording allows two files to be recorded simultaneously at different levels.
- Automatic recording function that starts recording when the set audio input level is detected
- File incrementing function allows a recording to be split by creating new files at times set in advance and whenever desired
- Pre-recording function allows the unit to record the 2 seconds of sound before recording is activated
- Automatic level function allows recording to always be at the optimal level
- Limiter function automatically reduces parts to suitable levels if the input level is too high
- Low cut filter with three cutoff frequencies useful for reducing low-frequency noise
- Variable speed function can adjust the playback speed between 50% and 150% (in 10% increments) of normal without changing the pitch
- Jumpback play function allows the last several seconds of the currently played file to be replayed again by simply pressing a button
- Playlist function
- Mark function convenient for moving to specific locations
- Divide function allows files to be split at positions set with the mark function and wherever desired (only with WAV files)
- File name format can be set to use a user-defined word or the date
- Resume function remembers the playback position when the unit is turned off
- 128×64 dot-matrix LCD with backlight
- Can be powered using the included AC adapter (TASCAM PS-P1220E) or 4 AA batteries
- 2 balanced mic/line inputs (XLR/TRS combo jacks)
- 1U rackmount size

This product has a Blackfin® 16/32-bit embedded processor made by Analog Devices, Inc. This processor controls the unit's digital signal processing.

Inclusion of this Blackfin® processor in the product increases its performance and reduces its power consumption.

Included items

This product includes the following items.

Keep the packing materials for transportation in the future.

Please contact TASCAM Customer Support (see back of manual) if any of these items are missing or have been damaged during transportation.

- Main unit× 1
- AC adapter (TASCAM PS-P1220E).....× 1
- Rackmount screw kit.....× 1
- Owner's Manual (this document) including warranty× 1

CAUTION

Always use the included AC adapter (TASCAM PS-P1220E) when using this unit. Moreover, never use the included AC adapter with any other device. Using the wrong adapter could cause damage, fire or electric shock.

NOTE

The included AC adapter (TASCAM PS-P1220E) is shipped with alternate outlet plugs. For details about how to change the plugs, see page 16.

Conventions used in this manual

The following conventions are used in this manual.

- When we refer to buttons, connectors and other parts of this unit, we use a bold font like this: **MENU** button.
- When we show messages, for example, that appear on the unit's display, the typeface looks like this: **BROWSE**.
- "SD card" indicates SD, SDHC and SDXC memory cards.
- Information shown on a computer display is placed in quotes like this: "OK".
- Additional information is provided as necessary as tips, notes and cautions.

TIP

These are tips about how to use the unit.

NOTE

These provide additional explanations and describe special cases.

CAUTION

Failure to follow these instructions could result in injury, damage to equipment or lost recording data, for example.

1 – Introduction

Trademarks and copyrights

- TASCAM is a trademark of TEAC CORPORATION, registered in the U.S. and other countries.
- SDXC Logo is a trademark of SD-3C, LLC.



- Blackfin® and the Blackfin logo are registered trademarks of Analog Devices, Inc.
- Other company names, product names and logos in this document are the trademarks or registered trademarks of their respective owners.

Information is given about products in this manual only for the purpose of example and does not indicate any guarantees against infringements of third-party intellectual property rights and other rights related to them. TEAC Corporation will bear no responsibility for infringements on third-party intellectual property rights or other liabilities that occur as a result of the use of this product.

Properties copyrighted by third parties cannot be used for any purpose other than personal enjoyment and the like without the permission of the right holders recognized by copyright law. Always use this equipment properly. TEAC Corporation will bear no responsibility for rights infringements committed by users of this product.

Precautions for placement and use

- The operating temperature range of this unit is 0–40 °C.
- Do not install this unit in the following types of locations. Doing so could make the sound quality worse or cause malfunction.
 - Places with significant vibrations
 - Near windows or other places exposed to direct sunlight
 - Near heaters or other extremely hot places
 - Extremely cold places
 - Places with bad ventilation or high humidity
 - Very dusty locations
- To enable good heat dissipation, do not place anything on top of the unit.
- Do not place this unit on top of a power amplifier or other device that generates heat.
- To mount this unit in a rack, use the included rackmount screw kit and mount it as shown in the illustration below. Leave at least 1U of space open above it in the rack.

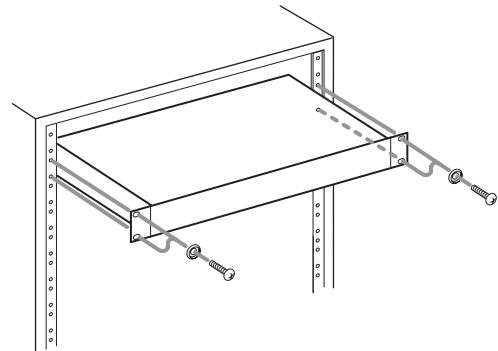

Beware of condensation

Condensation could occur if the unit is moved from a cold place to a warm place, it is used immediately after a cold room has been heated or it is otherwise exposed to a sudden temperature change. To prevent this, or if this occurs, let the unit sit for one or two hours at the new room temperature before using it.

Cleaning the unit

To clean the unit, wipe it gently with a soft dry cloth. Do not wipe with chemical cleaning cloths, thinner, alcohol or other chemical agents. Doing so could damage the surface or cause discoloration.

About SD cards

This unit uses SD cards for recording and playback.

It can use 64MB–2GB SD cards, 4–32GB SDHC cards and 48–128GB SDXC cards.

A list of SD cards that have been confirmed for use with this unit can be found on the TEAC Global Site (<http://teac-global.com/>).

You can also contact TASCAM customer support for information.

Precautions for use

SD cards are delicate media. In order to avoid damaging SD cards, please take the following precautions when handling them.

- Do not leave them in extremely hot or cold places.
- Do not leave them in extremely humid places.
- Do not let them get wet.
- Do not put things on top of them or twist them.
- Do not hit them.
- Do not remove or insert them during recording, playback, data transmission or other access.
- When transporting them, put them into cases, for example.

Using the TEAC Global Site

You can download the Owner's Manual necessary for this unit from the TEAC Global Site (<http://teac-global.com/>).

1. Open the TEAC Global Site (<http://teac-global.com/>).
2. In the TASCAM Downloads section, click the desired language to open the Downloads website page for that language.

NOTE

If the desired language does not appear, click Other Languages.

3. Click the product name in the "Search by Model Name" section to open the Downloads page for that product.
4. Select and download the Owner's Manual that are needed.

User registration

Customers in the USA, please visit the TASCAM website (<http://tascam.com/>) to register as a user online.

2 – Names and functions of parts

Front panel

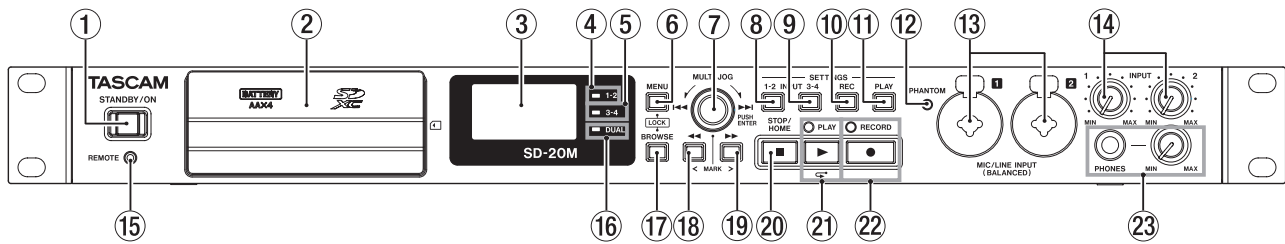

① STANDBY/ON button

Press and hold to turn the unit on/off (standby).

CAUTION

Before turning the unit on, lower the volumes of connected equipment to their minimum levels.

Failure to do so might cause sudden loud noises, which could harm your hearing or result in other trouble.

② Front cover

This covers the battery compartment and the SD card slot.

③ Display

Shows a variety of information.

④ 1-2 indicator

This lights when the INPUT 1-2 screen REC item is set to MONO 1 or STEREO 1-2. (See “Setting the recording input sources” on page 19.)

⑤ 3-4 indicator

This lights when the INPUT 3-4 screen REC item is set to ON. (See “Setting the recording input sources” on page 19.)

⑥ MENU button

When the Home Screen is open, press this button to open the MENU screen.

When the MENU screen is open, press this button to return to the Home Screen.

Press this button to return to the MENU screen from the various setting screens.

Press the **BROWSE** button and this button at the same time to open the KEY LOCK screen. (See “Setting the key lock function” on page 18.)

⑦ MULTI JOG dial

This functions both as a dial when turned and as a button when pressed.

Dial functions

- Turn toward ►► during playback or when stopped to skip to the next file.
- Turn toward ◄◄ during playback or when stopped within one second of a file beginning to skip to the previous file. When more than one second from a file beginning, turn this way to return to the beginning of the current file.
- When in menu mode, turn to select items and change setting values.
- When editing names, use to select characters.
- When the BROWSE screen is open, turn this to select folders and files within the current folder. (See “Screen navigation” on page 27.)

Button functions

- Press to confirm selections and settings (ENTER button function).

- On the setting screens, use to move the cursor left and right.

- When the BROWSE screen is open, press this to show the pop-up folder/file menu for the selected folder/file. See “Folder operations” on page 27 and “File operations” on page 28.

- Press during recording to add a mark. (See “Adding marks manually to a recording” on page 24.)

⑧ INPUT SETTINGS 1-2 button

Press this button to open the INPUT 1-2 screen. (See “Opening the INPUT 1-2 and INPUT 3-4 screens” on page 19.)

When the INPUT 1-2 screen is open, press this button to return to the Home Screen.

⑨ INPUT SETTINGS 3-4 button

Press this button to open the INPUT 3-4 screen. (See “Opening the INPUT 1-2 and INPUT 3-4 screens” on page 19.)

When the INPUT 3-4 screen is open, press this button to return to the Home Screen.

⑩ REC SETTINGS button

Press this button to open the REC SETTING screen. (See “Opening the REC SETTING screen” on page 19.)

When the REC SETTING screen is open, press this button to return to the Home Screen.

⑪ PLAY SETTINGS button

Press this button to open the PLAY SETTING screen. (See “Opening the PLAY SETTING screen” on page 30.)

When the PLAY SETTING screen is open, press this button to return to the Home Screen.

⑫ PHANTOM indicator

This indicator lights when phantom power is on.

⑬ MIC/LINE INPUT (BALANCED) 1/2 jacks

These balanced analog jacks are combined XLR mic and standard TRS inputs.

XLR (1: GND, 2: HOT, 3: COLD)

TRS (Tip: HOT, Ring: COLD, Sleeve: GND)

2 – Names and functions of parts

CAUTION

- Before making connections, turn this unit and all equipment to be connected off (or put them into standby).
- Confirm that phantom power is OFF before connecting a line level device to a MIC/LINE INPUT (BALANCED) 1/2 jack. If you connect a line level device while phantom power is being supplied, that device and this unit could be damaged.
- Do not connect or disconnect mics with the MIC/LINE INPUT (BALANCED) 1/2 jacks when the phantom power is set to ON. Doing so could cause a loud noise and might damage the equipment.
- Turn phantom power ON only when using a condenser microphone that requires phantom power. Turning phantom power on when a dynamic mic or other mic that does not require it is connected could damage this unit and connected equipment.
- When using condenser mics that require phantom power and dynamic mics together, be sure to use balanced dynamic mics. Unbalanced dynamic mics cannot be used when phantom power is enabled.
- Supplying phantom power to some ribbon mics will break them. If you are unsure, do not supply phantom power to a ribbon mic.
- Some condenser microphones will not operate when phantom power is set to 48V.

14 INPUT 1 and 2 knobs

Use these to adjust input levels

15 REMOTE connector (2.5mm TRS jack)

Connect a TASCAM RC-3F footswitch or TASCAM RC-10 wired remote control (both sold separately) here. This enables remote starting and stopping of playback and other functions.

16 DUAL indicator

This lights when dual recording is on. (See “Enabling dual recording” on page 25.)

17 BROWSE button

Press this to open the BROWSE screen. (See “Opening the BROWSE screen” on page 27.)

When the BROWSE screen is open, press this button to return to the Home Screen.

Press the MENU button and this button at the same time to open the KEY LOCK screen. (See “Setting the key lock function” on page 18.)

18 ◀◀ button

Press this button during playback or when stopped to move to the previous mark.

Press and hold this button during playback to search backward.

On the setting screens, use this button to move the cursor left.

On the BROWSE screen, press this button to move up a level.

19 ▶▶ button

Press this button during playback or when stopped to move to the next mark.

Press and hold this button during playback to search forward.

Press this button during recording to create a new numbered file and continue recording. (See “Splitting files manually while recording” on page 23.)

On the setting screens, use this button to move the cursor right.

On the BROWSE screen, press this button to move down a level. If a file is selected, the file is loaded and the unit returns to the Home Screen.

20 STOP/HOME [■] button

Press this button during playback to cause the playback to pause at the current position.

Press this button when paused to return to the beginning of the file being played.

Press this button when recording or in recording standby to stop recording.

When any other screen is open, press this button to return to the Home Screen.

21 PLAY [▶] button/indicator

When the Home Screen is open and the unit is stopped, press this button to start playback.

The PLAY indicator will light during playback.

During playback, press this button to jump back and continue playback.

Press when in recording standby to start recording.

The RECORD indicator will light during recording.

When the BROWSE screen is open and a file or folder is selected, press this button to return to the Home Screen and play that folder or file from the beginning.

22 RECORD [●] button/indicator

When stopped, press this button to put the unit into recording standby. The RECORD indicator will start to blink.

When in standby, press this button to start recording. The RECORD indicator lights when recording.

Press when recording to pause recording.

23 PHONES jack and knob

Use this standard stereo jack to connect stereo headphones. Use an adapter to connect headphones with a mini plug.

Use the PHONES knob to adjust the headphone output level.

CAUTION

Before connecting headphones, use the PHONES knob to minimize the volume. Failure to do so could result in a sudden loud noise that could harm hearing, for example.

Behind front cover

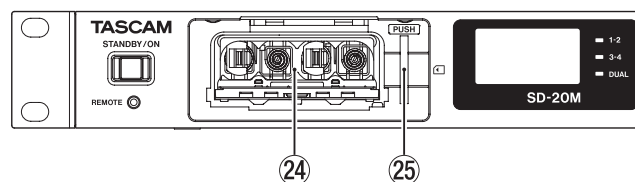

24 Battery compartment

Install batteries (4 AA) in this compartment to power the unit. (See “Using AA batteries” on page 16.)

25 SD card slot

Insert an SD card here.

2 – Names and functions of parts

Rear panel

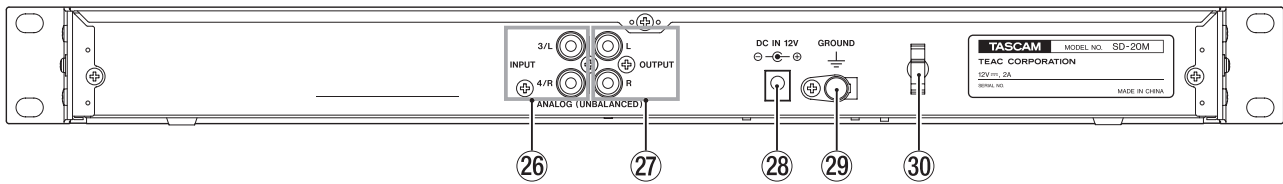

26 ANALOG (UNBALANCED) INPUT 3/L and 4/R jacks

These RCA pin jacks are analog inputs.
Their nominal input level is –10 dBV.

27 ANALOG (UNBALANCED) OUTPUT L and R jacks

These RCA pin jacks are analog outputs.
Their nominal output level is –10 dBV.

28 DC IN 12V connector

Connect the included AC adapter (TASCAM PS-P1220E) here.

29 GROUND connector

Depending on the conditions of use, noise might occur in the monitoring sound. If this occurs, connect this to a ground with a cable (not included).

30 Cord holder

Hook the cord of the included AC adapter here to prevent accidental disconnection.

Home Screen

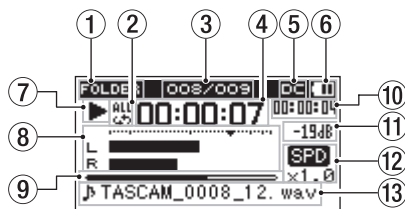

1 Playback area

This shows the current playback file area.

ALL	All files in the SOUND folder
FOLDER	All files in the selected folder
P. LIST	All files added to the playlist

2 Repeat playback setting

One of the following icons appears according to the current setting.

Icon	Meaning
	Single playback
	Single file repeat playback
	All file repeat playback

3 Current playback file number/total number of files

This shows the current file number and total number of files in the current playback area.

4 Elapsed time

This shows the elapsed time (hours: minutes: seconds) of the current file.

5 DC input status

When powering the unit with the included TASCAM PS-P1220E adapter, appears.

6 Battery supply status

A battery icon appears when power is supplied by batteries. When batteries are being used, the battery icon shows the amount of power remaining in bars (, ,). The battery is almost dead and the power will soon turn off if the icon with no bars blinks.

When no batteries are installed in the unit, appears.

NOTE

Sometimes a Battery Low warning appears when recording or conducting other demanding operations even when battery power remains.

7 Recorder operation status

This icon shows the recorder operation status.

Indicator	Meaning
	Stopped
	Paused
	Playing back
	Searching forward
	Searching backward
	Skipping to the beginning of the next file
	Skipping to the beginning of the current or previous file

8 Level meter

These show the levels of the input and playback signals.

9 Playback position display

The current playback position is shown by a bar. As playback progresses, the bar extends from the left.

10 Remaining time

This shows the elapsed time (hours: minutes: seconds) of the current file.

11 Peak value in decibels (dB)

The maximum level that occurs in a fixed period of time is displayed in decibels.

12 Playback speed setting status

This shows whether the variable speed function is on or off. (See “Changing the playback speed (VARI SPEED)” on page 31.)

No indicator	Variable speed off
	Variable speed on

2 – Names and functions of parts

13 File name

The file name or tag information of the file currently being played back is shown.

When ID3 tag information is available for an MP3 file being played, it is given priority for display.

NOTE

ID3 tag information includes the titles and artists names that can be saved in MP3 files.

Recording screen

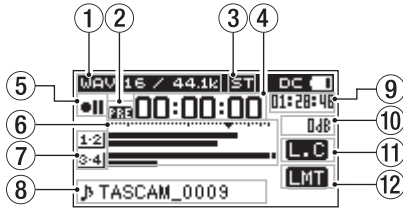

1 Recording format

This shows the file recording format and sampling frequency. (See “Setting the file format and sampling frequency” on page 22.)

2 Prerecording or automatic recording function setting status

PRE appears when the prerecording function is ON and the unit is in recording standby.

AUTO appears when the automatic recording function is ON and the unit is in recording standby or recording.

AMP appears when both the prerecording and automatic recording functions are ON, and the unit is in recording standby.

3 Number of recording channels

This shows the number of channels in recording files.

ST: Stereo

MM: Mono

4 Elapsed recording time

The elapsed recording time of the file appears as hours: minutes: seconds.

5 Recorder operation status

This icon shows the recorder operation status.

Indicator	Meaning
● II	Recording standby
●	Recording

6 Level meters

These show the input signal levels.

The b mark at the –12dB position on the scale is a guide for input level adjustment.

7 Input source indicators

These icons show the input sources being recorded. (See “Setting the recording input sources” on page 19.)

Icon	Meaning
1-2	Record input from the MIC/LINE INPUT 1 and 2 jacks.
1	Record input from the MIC/LINE INPUT 1 jack.
3-4	Record input from the ANALOG INPUT 3/L and 4/R jacks.
1-2 3-4	Record input from the MIC/LINE INPUT 1 and 2 and ANALOG INPUT 3/L and 4/R jacks.
1-2 -12	
1-2 LM	These appear when in dual recording mode for the dual input source. (See “Enabling dual recording” on page 25.)
1-2 AT	

8 File name

The file name that will automatically be given to recorded files is shown.

This shows the project name when there are multiple files recorded in 4-channel or dual recording modes.

9 Remaining recording time

The remaining recording time on the SD card is shown in hours: minutes: seconds according to the input source, file format and sampling frequency settings.

10 Peak value in decibels (dB)

Peak input level values are shown in decibels.

11 Low cut filter on/off status

This shows whether the low cut filter is on or off. (See “Setting the low-cut filter” on page 20.)

This icon appears when the low-cut filter is set to 40Hz, 80Hz or 120Hz.

No icon: Low cut filter off

L.C.: Low cut filter on

12 Level control function status

This icon shows whether the level control function is on or off. (See “Using the Level Control Function” on page 21.)

No icon: Level control off

LMT: Limiter on

ALC: Automatic level control on

Menu structure

Press the **MENU** button to open the **MENU** screen.

This list provides an overview of the various menu items.

Menu item	Function	Page
DIVIDE	Divide files.	page 33
FILE NAME	Set the file name format.	page 33
MEDIA INFO	View SD card information.	page 34
INITIALIZE	Restore the default settings.	page 34
SD FORMAT	Format SD cards.	page 34
BATTERY TYPE	Set the type of batteries.	page 35
AUTO PWR SAVE	Set the automatic power off function.	page 35
REMOTE	Make remote control settings.	page 36

2 – Names and functions of parts

Menu item	Function	Page
OUTPUT LEVEL	Adjust the level output to other devices.	page 35
DATE/TIME	Set the date and time	page 17
BACKLIGHT	Set the time until the backlight turns off.	page 35
CONTRAST	Adjust the display contrast	page 35
VERSION	Show system information	page 35

CAUTION

- *When recording or in recording standby, the MENU screen will not open.*
- *The settings for all menu items are retained even when the unit is turned off.*

Basic Menu Screen operations

Use the following operations to work with the pages of the MENU screen.

■ Selecting items (moving vertically on a screen):

Turn the **MULTI JOG** dial.

■ Confirming a selected item:

Press the **MULTI JOG** dial.

■ Opening a submenu from a screen:

Press the **MULTI JOG** dial.

■ Going back one level in a menu:

Press the **MENU** button.

■ Returning to the Home Screen from a menu:

Press the **STOP/HOME [■]** button.

Menu operation procedures

In this example, we explain how to change the time until the backlight turns off.

1. Press the **MENU** button to open the MENU screen.



2. Turn the **MULTI JOG** dial to select a menu item (highlighted).



BACKLIGHT selected

3. Press the **MULTI JOG** dial to open the settings screen.



BACKLIGHT screen

4. Turn the **MULTI JOG** dial to change the setting.

5. Press the **MENU** button to return to the MENU screen.
Press the **STOP/HOME [■]** button to return to the Home Screen.

Basic operation

Use the following buttons to operate the various screens.

■ MENU button

Opens the MENU screen.

When the MENU screen is open, returns to the Home Screen.

■ MULTI JOG dial

Turn the **MULTI JOG** dial to select items and change values on setting screens. You can also turn it to change the file playback position.

Push the **MULTI JOG** dial to confirm selections on setting screens and to answer "YES" or "ON" on confirmation pop-up messages.

■ INPUT SETTINGS 1-2 button

Opens the INPUT 1-2 screen.

When the INPUT 1-2 screen is open, returns to the Home Screen.

■ INPUT SETTINGS 3-4 button

Opens the INPUT 3-4 screen.

When the INPUT 3-4 screen is open, returns to the Home Screen.

■ REC SETTINGS button

Opens the REC SETTING screen.

When the REC SETTING screen is open, returns to the Home Screen.

■ PLAY SETTINGS

Opens the PLAY SETTING screen.

When the PLAY SETTING screen is open, returns to the Home Screen.

■ BROWSE button

Opens the BROWSE screen.

When the BROWSE screen is open, returns to the Home Screen.

■ ►► button

Use this to move the cursor (the highlighted area) to the right on the screen, and to open folders on the BROWSE screen.

■ ◀◀ button

Use this to move the cursor (the highlighted area) to the left on the screen, and to close folders on the BROWSE screen.

■ STOP/HOME [■] button

When any other screen is open, press the **STOP/HOME [■]** button to return to the Home Screen.

3 – Preparation

Connecting other equipment

This is an example of SD-20M connections.

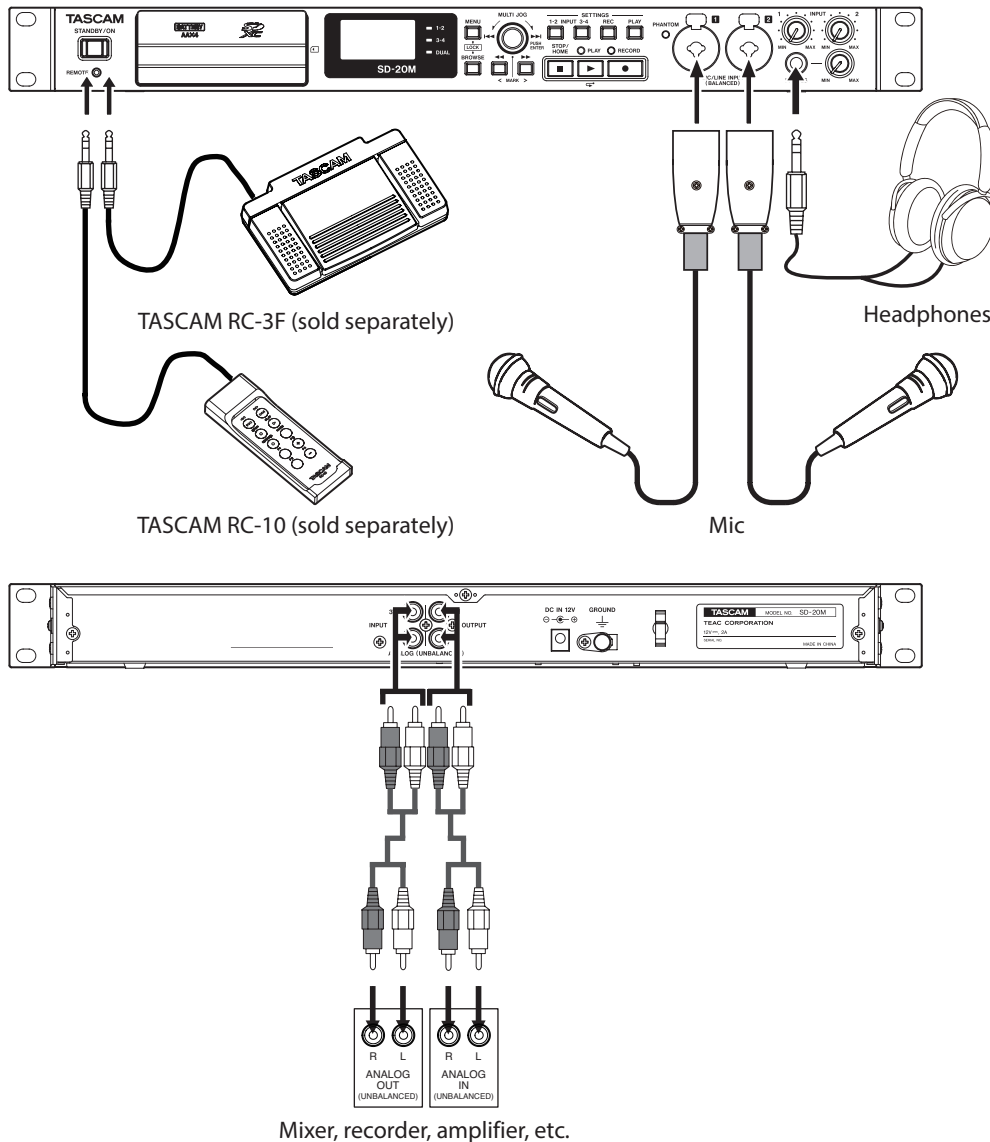

Examples of connections to an SD-20M

CAUTION

- Carefully read the operation manuals of the devices to be connected and then connect them correctly.
- Before making connections, turn this unit and all equipment to be connected off (or put them into standby).
- Install all connected devices, including this unit, so that they are powered from the same line. When using a power strip or similar device, be sure to use one that has high current capacity (thick cable) in order to minimize fluctuations in power voltage.
- The phantom power sets two input channels at a time. Do not turn phantom power on when connecting an unbalanced dynamic mic.
- Do not connect or disconnect mics while phantom power is on. Doing so could cause a loud noise and might damage this unit and connected equipment.
- Supplying phantom power to some ribbon mics will break them. If you are unsure, do not supply phantom power to a ribbon mic.
- Set the PHONES knob to its minimum value before changing a phantom power setting. Failure to do so could cause sudden loud noises from monitoring equipment, and this could damage equipment or harm hearing.
- Reduce the output level of the external audio device if the input sound is distorted even when reducing the input gain level on the unit.
- When an external audio device with a fixed line output level is connected, level overloads might occur and adjusting the gain level might not be possible because of loud sound sources, for example. In such cases, use the headphone jack or another level-controllable output for connection to the unit.

3 – Preparation

Powering the unit

Power sources

This unit can be powered by connecting the included AC adapter (TASCAM PS-P1220E) or with 4 AA batteries.

This unit can use alkaline, Ni-MH or lithium AA batteries.

Using an AC adapter

Use the included AC adapter (TASCAM PS-P1220E) to connect a power supply to the unit as shown below.

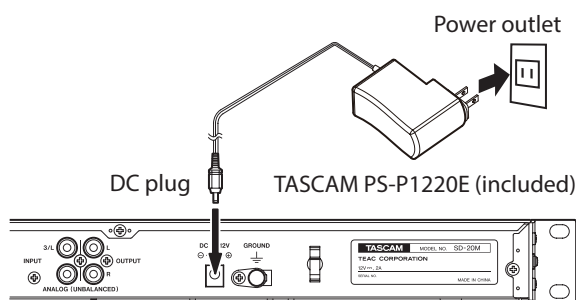

In order to prevent the cord from becoming disconnected during use, wrap it around the cord holder when connecting it.

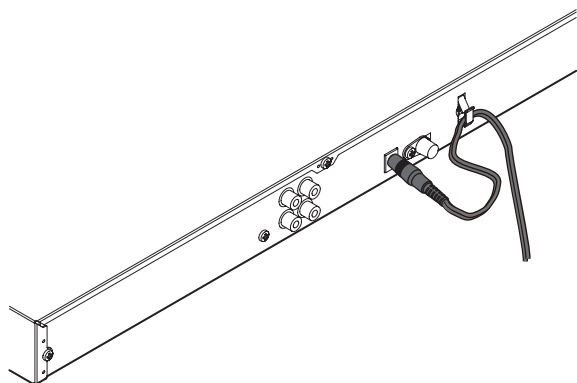

CAUTION

Always use the AC adapter (TASCAM PS-P1220E) that was included in the package with this unit. Using a different AC adapter could cause malfunction, overheating, fire or other problems.

NOTE

- The AC adapter for the unit includes two types of outlet plugs. Attach the type of plug that matches the power outlet that you are using. (See "Changing the outlet plug" on page 16.)
- When both batteries are installed and the AC adapter is connected, power will be supplied from the AC adapter.

Changing the outlet plug

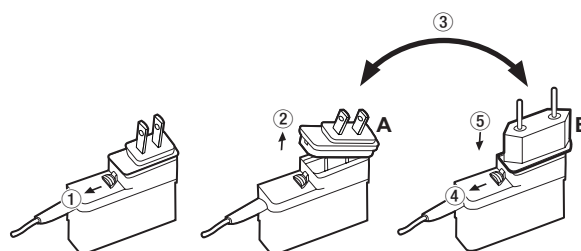

- ① Move the latch on the AC adapter in the direction of the arrow.
- ② Pull off the outlet plug.
- ③ Replace it with the other outlet plug (A or B).
- ④ Move the latch on the AC adapter in the direction of the arrow again.
- ⑤ Attach the outlet plug to the AC adapter.

After changing the outlet plug, confirm that it is not loose or crooked and that everything is normal before plugging it into an outlet

CAUTION

Do not use the adapter if there is anything abnormal about the plug after changing it. Use when the plug is abnormal could cause fire or electric shock. Contact the retailer where you purchased the unit or a TEAC service center (on the back cover) to request repair.

Using AA batteries

Open the front cover and battery compartment. Install 4 AA batteries in the compartment with the ⊕ and ⊖ marks as shown. Then, close the battery compartment and front cover.

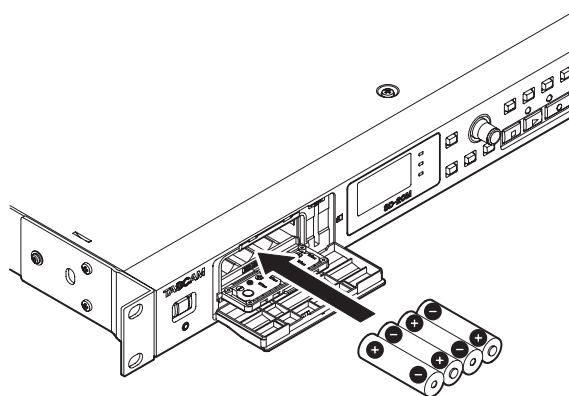

When using AA batteries, set the type of battery in order to accurately show the amount of power remaining and allow the unit to accurately determine whether power is available for proper operation. (See "Setting the type of batteries" on page 35.)

CAUTION

- Manganese dry cell batteries cannot be used with this unit.
- This unit cannot recharge Ni-MH batteries. Use a commercially available recharger.

NOTE

A great amount of power is required to provide phantom power to a condenser microphone. If you use a condenser microphone while running the unit on AA batteries

(alkaline, Ni-MH or lithium), the operation time will be shortened.

If you need to operate the unit for a long time, use the included AC adapter (TASCAM PS-P1220E) to power the unit.

Turning the power on and off (putting it in standby)

CAUTION

- The unit enters standby mode if the power is turned off when using the included AC adapter (TASCAM PS-P1220E).
- Turn down the volume of the monitoring system connected to the unit before turning the unit on/off (standby).
- Do not use headphones when turning the unit on/off (standby). Loud noises could damage the speakers or harm your hearing.

Turning the unit on

To start the unit when off (in standby), press and hold the **STANDBY/ON** switch until TASCAM SD-20M (start-up screen) appears on the display.

The Home Screen appears after the unit starts up.



Start-up Screen

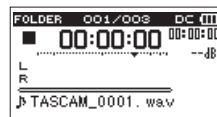

Home Screen

Turning the unit off (putting it in standby)

When on, press and hold the **STANDBY/ON** switch until LINEAR PCM RECORDER appears on the display.

The unit turns off after it completes its shutdown process.

CAUTION

Always use the **STANDBY/ON** switch to turn the unit off (put it in standby).

While the unit is on, do not remove the batteries or disconnect the power cord when using the included AC adapter (TASCAM PS-P1220E). Doing so will cause all recordings, settings and other data to be lost. Lost data and settings cannot be restored.

Resume function

The unit has a resume function. When started up, the unit locates the position (time) where it was when last shut down.

If the **PLAY [▶]** button is pressed after start-up, the file the unit was playing when shut down (put in standby) previously resumes playback from the position (time) where it was.

NOTE

This data is stored on the SD card. The resume function will not work if the card is changed or formatted.

Setting the date and time

Using its internal clock, this unit remembers the date and time when a file is recorded.

1. Select the **DATE/TIME** item on the **MENU** screen to open the **DATE/TIME** screen. (See “Menu operation procedures” on page 14.)



2. Turn the **MULTI JOG** dial to change a value, and press the **MULTI JOG** dial to confirm it and move the cursor to the next item.

After you change the year, month, day, hour, minute and second in order, the cursor will return to the year.

3. Press the **MENU** button to confirm and return to the **MENU** screen.

NOTE

You can set the unit to automatically add the date to file names. (See “Setting the file name format” on page 33.)

3 – Preparation

Inserting and removing SD cards

Inserting the card

1. Open the front cover on the front of the unit.
2. Insert an SD Card into the slot as shown in the illustration until it clicks into place.

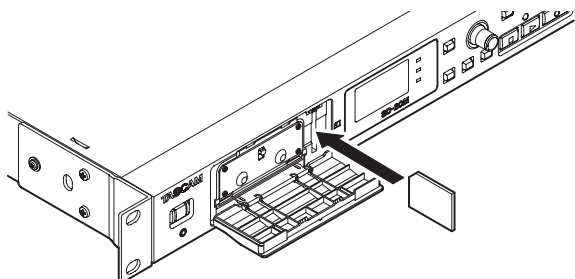

Removing the card

1. Open the front cover on the front of the unit.
2. Press the SD card in gently and then release it to allow it to come out.

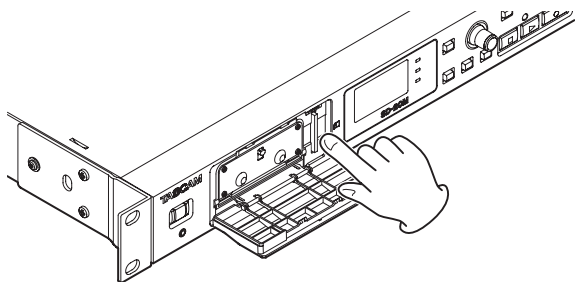

CAUTION

- Do not remove the SD card from the unit during recording, playback or at other times when it is being accessed.
- SD cards that meet SD, SDHC or SDXC standards can be used with this unit.
- A list of SD cards that have been confirmed to work with this unit can be found on the TEAC Global Site (<http://teac-global.com/>).

SD card write protection switches

SD cards have protection switches that prevent writing new data to them.

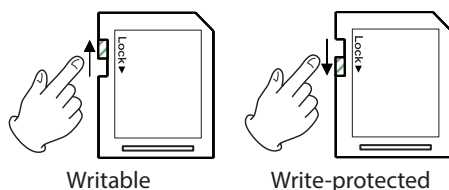

If you slide the protect switch to the LOCK position, file recording and editing will not be possible. Move the switch to the unlocked position in order to record, erase and otherwise edit data on the card.

Preparing an SD card for use

In order to use an SD card in this unit, you must format it first.

1. Confirm that an SD card is installed and turn the power ON.
2. The following message appears when a new card or a card formatted for use with another device is installed in the unit.

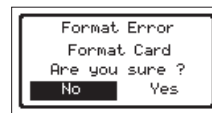

3. Turn the **MULTI JOG** dial to select Yes, and press the **MULTI JOG** dial to start formatting.
To cancel formatting, select No, and press the **MULTI JOG** dial to return to the MENU screen.

CAUTION

Formatting a card erases all the data on it.

4. When formatting ends, the Home Screen opens. You can also reformat the card in this unit at any time.

CAUTION

When formatting, the unit should be operating using the included AC adapter (TASCAM PS-P1220E) or batteries with sufficient remaining power.

Setting the key lock function

You can set the key lock function to prevent this unit from being controlled by its front panel buttons.

1. Press the **BROWSE** button while pressing and holding the **MENU** button to open the KEY LOCK screen.



2. Turn the **MULTI JOG** dial to select which button operations to disable, and press it to confirm.

Options	Meaning
OFF (default value)	The lock function is off.
ALL KEYS	This locks the operation of all buttons and the MULTI JOG dial.
SETTING KEYS	This locks the operation of the MENU and SETTINGS buttons.

3. After making the setting, the Home Screen reopens.

NOTE

- Operation of a remote control (TASCAM RC-3F/RC-10) connected to the **REMOTE** jack will not be locked.
- A pop-up message will appear if you press one of the buttons that is disabled by the key lock function being on.



4 – Recording

This unit can record sound from external microphones and external audio devices, including CD players.

You can select among MP3 (44.1/48 kHz, 32–320 kbps) and WAV/BWF (44.1/48/96 kHz, 16/24-bit) audio recording formats.

Marks added when recording to Broadcast Wave Format (BWF) can be used with software that supports this format, for example.

This recorder has a variety of recording formats, including dual recording, which allows an audio file to be recorded at two different levels, and simultaneous 4-channel recording, which allows mics to be used with connected audio equipment.

Setting where to save files

Set the folder where recorded files are saved.

Recorded files will be saved in the currently selected folder. For details, see the **SELECT** pop-up menu item under “Folder operations” on page 27.

If no setting is made, new files are created in the **SOUND** folder.

Opening the INPUT 1-2 and INPUT 3-4 screens

Press the **INPUT SETTINGS 1-2** or **INPUT SETTINGS 3-4** button to open the **INPUT 1-2** or **INPUT 3-4** screen.

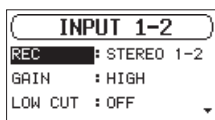

INPUT 1-2 screen

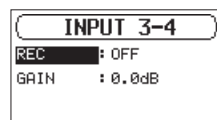

INPUT 3-4 screen

Press the **INPUT SETTINGS 1-2** or **INPUT SETTINGS 3-4** button when the **INPUT 1-2** or **INPUT 3-4** screen is open to return to the Home Screen.

CAUTION

*When in recording standby or recording, only the **GAIN** and **LOW CUT** items on the **INPUT 1-2** screen and the **GAIN** item on the **INPUT 3-4** screen can be set.*

Opening the REC SETTING screen

Press the **REC SETTINGS** button to open the **REC SETTING** screen.

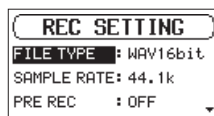

When the **REC SETTING** screen is open, press the **REC SETTINGS** button to return to the Home Screen.

Setting the recording input sources

Use the **REC** items on the **INPUT 1-2** and **INPUT 3-4** screens to set the recording input sources.

1. Select the **REC** item on the **INPUT 1-2** or **INPUT 3-4** screen. (See “Opening the **INPUT 1-2** and **INPUT 3-4** screens” on page 19.)

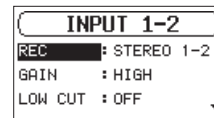

INPUT 1-2 screen

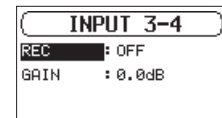

INPUT 3-4 screen

2. Set the input source.

Screen	Options	Meaning
INPUT 1-2 screen	OFF	No input
	MONO 1	Input from the MIC/LINE INPUT 1 jack
	STEREO 1-2 (default value)	Input from the MIC/LINE INPUT 1 and 2 jacks
INPUT 3-4 screen	OFF (default value)	No input
	ON	Input from the ANALOG INPUT 3/L and 4/R jacks

3. When finished, press the **STOP/HOME [■]** button to return to the Home Screen.

NOTE

- *The **REC** items on the **INPUT 1-2** and **INPUT 3-4** screens cannot both be set to **OFF** at the same time. After setting the input source of the recording channel, turn the other channels **OFF**.*
- *When the **INPUT 1-2** screen **REC** item is set to **MONO 1**, if the **INPUT 3-4** screen **REC** item is set to **ON**, the **INPUT 1-2** screen **REC** item will be reset to **STEREO 1-2** automatically.*
- *When the **INPUT 3-4** screen **REC** item is set to **ON**, if the **INPUT 1-2** screen **REC** item is set to **MONO 1**, the **INPUT 3-4** screen **REC** item will be reset to **OFF** automatically.*

4 – Recording

Adjusting the input level

Before starting recording, input levels should be adjusted to prevent recorded sounds or signals from being distorted due to excessive input levels and to prevent them from being so low that they are below the noise floor.

In addition to manual adjustment, the unit has two other level adjustment functions: automatic level control and a limiter. Use these as needed. (See “Using the Level Control Function” on page 21.)

TIP

In addition to adjusting input levels, try changing the distances and angles between the microphones and the sound sources. The angles and distances of the microphones can also change the character of the recorded sound.

CAUTION

Manual adjustment cannot be performed when the automatic level control function is selected (ALC appears to the right of the elapsed time on the recording screen). To enable manual input level adjustment, turn the level control function off or select a different mode. (See “Using the Level Control Function” on page 21.)

1. Press the **INPUT SETTINGS 1-2** or **INPUT SETTINGS 3-4** button to open the **INPUT 1-2** or **INPUT 3-4** screen. (See “Opening the INPUT 1-2 and INPUT 3-4 screens” on page 19.)
2. Select the **GAIN** item and set the input gain.

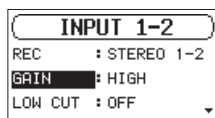

INPUT 1-2 screen

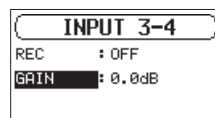

INPUT 3-4 screen

Screen	Options	Meaning
INPUT 1-2 screen	HIGH (default value)	Use when connecting mics to this unit's MIC/LINE INPUT 1 and 2 connectors.
	LOW	Use when connecting the line output jacks of external devices to this unit's MIC/LINE INPUT 1 and 2 connectors.
INPUT 3-4 screen	0dB (default) -16dB (in 0.5dB increments)	Use to set the input gain when connecting the line output jacks of external devices to this unit's ANALOG INPUT 3/L and 4/R connectors.

NOTE

The HIGH and LOW settings have different input gains. Choose the setting according to the input level. If you are not sure which setting to use, try LOW first. If the input level is too low even after adjustment, return to this screen and set it to HIGH.

CAUTION

Depending on this setting, the input level setting range changes. For this reason, the input level might change greatly when this setting is changed. Before changing it, turn the output level all the way down.

3. When finished, press the **STOP/HOME [■]** button to return to the Home Screen.

4. Press the **RECORD [●]** button to start recording standby. The **RECORD** indicator flashes red and the recording screen appears.



5. Use the **INPUT 1-2** knobs to adjust the input levels.

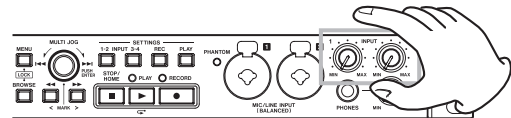

6. When finished making the setting, press the **STOP/HOME [■]** button to end recording standby.

Setting the low-cut filter

The low-cut filter can reduce bothersome noise, such as from wind, air-conditioners and projectors.

1. Select the **LOW CUT** item on the **INPUT 1-2** screen. (See “Opening the INPUT 1-2 and INPUT 3-4 screens” on page 19.)

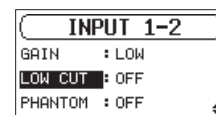

2. Sets the cutoff frequency of the low-cut filter used during input.
Options: OFF (default value), 40Hz, 80Hz, 120Hz
3. When finished, press the **STOP/HOME [■]** button to return to the Home Screen.

NOTE

LOW CUT can be set when recording/in recording standby.

Setting phantom power

Phantom power can be turned on when an mic that requires it is connected to a **MIC/LINE INPUT (BALANCED) 1/2** jack.

1. On the **INPUT 1-2** screen, select the **PHANTOM** item. (See “Opening the INPUT 1-2 and INPUT 3-4 screens” on page 19.)

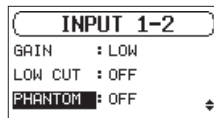

2. Turn phantom power on or off.
Options: OFF (default), ON
3. When finished, press the **STOP/HOME [■]** button to return to the Home Screen.

Phantom power (48V) is turned on and supplied to the mics connected to the **MIC/LINE INPUT (BALANCED) 1/2** jacks.

CAUTION

- Before making connections, turn this unit and all equipment to be connected off (or put into standby).
- Confirm that phantom power is OFF before connecting a line level device to a **MIC/LINE INPUT (BALANCED) 1/2** jack. If you connect a line level device while phantom power is being supplied, that device and this unit could be damaged.
- Do not connect or disconnect mics with the **MIC/LINE INPUT (BALANCED) 1/2** jacks when the phantom power is set to ON. Doing so could cause a loud noise and might damage the equipment.
- Turn phantom power ON only when using a condenser microphone that requires phantom power. Turning phantom power on when a dynamic mic or other mic that does not require it is connected could damage this unit and connected equipment.
- When using condenser mics that require phantom power and dynamic mics together, be sure to use balanced dynamic mics. Unbalanced dynamic mics cannot be used when phantom power is enabled.
- Supplying phantom power to some ribbon mics will break them. If you are unsure, do not supply phantom power to a ribbon mic.
- Some condenser microphones will not operate when phantom power is set to 48V.

Using the Level Control Function

You can set the input level control function.

1. On the **INPUT 1-2** screen, select the **LVL CTRL** item. (See “Opening the INPUT 1-2 and INPUT 3-4 screens” on page 19.)

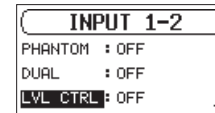

2. Set the level control function used.

Option	Meaning
OFF (default value)	This turns the level control function off.
LIMITER	This prevents distortion of sound due to sudden excessive input.
AUTO LEVEL	When the input sound level is too low or too high, the input level will be increased or decreased automatically to an appropriate level.

3. When finished, press the **STOP/HOME [■]** button to return to the Home Screen.
An icon for the set level control function will appear on the Home Screen.

CAUTION

*Distortion of sounds may occur when signals that are very loud are input even if the **LIMITER** function is activated. In such a case, lower the input level or manually.*

NOTE

*The input level cannot be changed if the level control function is set to **AUTO LEVEL**. (See “Adjusting the input level” on page 20.)*

4 – Recording

Setting the file format and sampling frequency

Use the **FILE TYPE** and **SAMPLE RATE** items on the **REC SETTING** screen to set the recorded audio file format before you start recording. (See “Opening the **REC SETTING** screen” on page 19.)

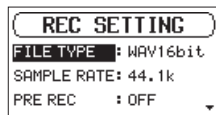

■ Setting the file format

Select the **FILE TYPE** item and set the file format.

- Options: BWF16bit, BWF24bit, WAV16bit (default), WAV24bit, MP3 32k (bps), MP3 64k (bps), MP3 96k (bps), MP3 128k (bps), MP3 192k (bps), MP3 256k (bps), MP3 320k (bps)

NOTE

- *BWF is a format created for broadcasting that has the same sound quality as the standard WAV format. It also uses the same “.wav” file extension as WAV files. In this manual, we distinguish these file types by using the terms BWF and WAV.*
- *WAV/BWF files are higher quality than MP3 files.*
- *MP3 files allow for longer recordings than WAV/BWF files.*
- *Higher values for MP3 files provide better recording quality.*

■ Setting the sampling frequency

Select the **SAMPLE RATE** item and set the sampling frequency.

- Options: 44.1k (default), 48k (Hz), 96k (Hz)

NOTE

96k cannot be selected if the file type is MP3.

Recording (MONO/STEREO/4ch)

Starting recording

1. Press the **RECORD** [●] button to start recording standby.

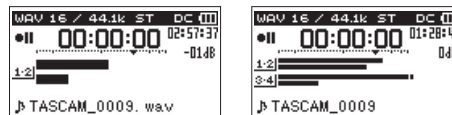

When 2ch recording When 4ch recording

The screen shows the recording file name, input source, recording audio file type and sampling frequency. Please confirm that these are as desired before starting recording.

2. Press the **PLAY** [▶] or **RECORD** [●] button to start normal recording.

When recording starts, the **RECORD** indicator lights continuously, and the display shows the elapsed recording time and the remaining recording time.

3. Press the **STOP/HOME** [■] button to finish recording.

To pause recording, press the **PLAY** [▶] or **RECORD** [●] button.

Press the **PLAY** [▶] or **RECORD** [●] button again to resume recording in the same file.

If you press the **STOP/HOME** [■] button after pausing, an audio file of the recording is created up to the moment that it was paused.

File names when recording in MONO/STEREO

TASCAM_0001.WAV
① ②

- ① Set with the **WORD** item on the **FILE NAME** screen
- ② Recording file project number

File names when recording 4 channels

In 4-channel recording, a set of two files is created. One is for channels 1-2 and one is for channels 3-4.

TASCAM_0002_12.WAV
① ② ③
TASCAM_0002_34.WAV
① ② ③

- ① Set with the **WORD** item on the **FILE NAME** screen
- ② Recording file project number
- ③ Assigned source channels
(1,2 → channels 1-2, 3,4 → channels 3-4)

Recording the moment before pushing RECORD (PRE REC)

By using prerecording, you can record up to two seconds of the signal input when the unit is in recording standby before the record button is pushed (PRE REC).

1. Select the PRE REC item on the REC SETTING screen. (See “Opening the REC SETTING screen” on page 19.)

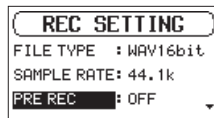

2. Turn the pre-recording function on or off.
Options: OFF (default), ON
3. When finished, press the **STOP/HOME** [■] button to return to the Home Screen.

TIP

By using this in combination with the AUTO REC function, you can record events without losing the beginnings of sounds.

NOTE

If the amount of time in record standby is less than two seconds, the sound for that amount of time is recorded.

Creating a new file while continuing to record (file splitting)

You can manually split a recording. This function creates a new file and continues recording. You can also set the unit to split recordings automatically at set times (file splitting functions).

NOTE

- *When new files are created, incremental numbers are added to the end of each file name.*
- *If the name of a file to be created would be the same as that of an existing file, the number will be incremented until the new file has a unique name.*

Splitting files manually while recording

During recording, press the ►► button at any time to easily create a new file while continuing to record.

CAUTION

- *A new file cannot be created if the total number of folders and files would exceed 5000.*
- *Files shorter than two seconds cannot be created. Moreover, if the sampling frequency is 96 kHz, files shorter than four seconds cannot be created.*

Splitting files automatically at set times while recording

Without pausing recording, a new file can be created automatically during recording when the file size set in advance with the REC SETTING screen AUTO SPLIT item is exceeded.

Follow these procedures to set the maximum file time that triggers automatic file-splitting.

1. Select the AUTO SPLIT item on the REC SETTING screen. (See “Opening the REC SETTING screen” on page 19.)

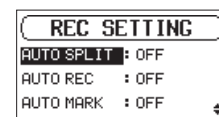

2. Set the time that triggers automatic file-splitting.
Options: OFF (default), 5min, 10min, 15min, 30min, 60min
3. When finished, press the **STOP/HOME** [■] button to return to the Home Screen.

CAUTION

A new file cannot be created if the total number of folders and files would exceed 5000.

4 – Recording

Starting recording automatically (AUTO REC)

When the automatic recording function is on, the unit responds to input sound levels to start and pause recording and creates new files.

Setting the automatic recording function

1. Select the **AUTO REC** item on the **REC SETTING** screen. (See “Opening the REC SETTING screen” on page 19.)

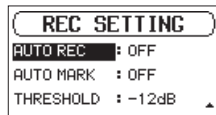

2. Turn the automatic recording function on or off.
Options: OFF (default), ON
3. Select the **THRESHOLD** item on the **REC SETTING** screen, and set the automatic recording starting level, which is the level that the unit recognizes as an input signal.

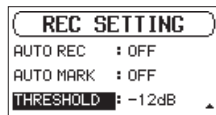

Options: -6dB, -12dB (default), -24dB, -48dB

4. When finished, press the **STOP/HOME** [■] button to return to the Home Screen.

Recording using the automatic recording function

Press the **RECORD** [●] button to start recording standby.

- Recording starts automatically when the input signal exceeds the level set with the **THRESHOLD** item on the **REC SETTING** screen.
- The unit pauses recording (resumes recording standby) when the input signal level falls below the **THRESHOLD** for more than 5 seconds. When the input signal level becomes higher than the **THRESHOLD** again, recording to a new file starts.

Press the **STOP/HOME** [■] button to stop automatic recording.

TIP

*By using this in combination with the **PRE REC** function, you can record events without losing the beginnings of sounds.*

Using mark functions

Adding marks manually to a recording

During recording or when recording is paused, press the **MULTI JOG** dial to add a mark at that point manually.

The added mark number appears in a pull-up at the bottom of the display.



NOTE

- The maximum number of marks that can be added to each file is 99. The mark data is stored in the file.
- Marks added to BWF format WAV files by this unit during recording are stored in the file. These marks can be used when playing back the file using software or equipment that supports the BWF format.

Adding marks automatically when recording

With the automatic mark function, after the input signal level stays below the set **THRESHOLD** level for more than 5 seconds, the unit adds a mark automatically when the input signal level becomes higher than the **THRESHOLD** again.

1. Select the **AUTO MARK** item on the **REC SETTING** screen. (See “Opening the REC SETTING screen” on page 19.)

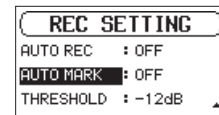

2. Set whether or not marks are added automatically during recording.
Options: OFF (default), ON
3. When finished, press the **STOP/HOME** [■] button to return to the Home Screen.

Moving to a mark position

When stopped or during playback, use the ◀◀ and ▶▶ buttons to move between marks in the selected file.

You can use this function to identify points to create shortcuts to the beginning of songs, for example.

NOTE

- You cannot move to a mark in a different file.
- If a write error occurred during recording, a BOF Mark is stored. The mark is named “BOF [01]” with an incrementing number for reference.

Simultaneously recording two files at different input levels (DUAL REC)

This recorder can simultaneously record a second recording at a different input level along with the regular recording. For example, when recording with microphones, you can make an ordinary recording with the input level set as high as possible and simultaneously record at a lower input level setting (–12dB) for safety.

Two separate recorded files can be saved. One is at the normal input level and one has its input level adjusted as follows according to the application and conditions.

- File recorded 12dB lower than the ordinary recording input level
- File that avoids distortion when signals that are too loud are input suddenly
- File that has the recording volume increased or decreased automatically when the input level is too low or too high

NOTE

Make the input level setting for the ordinary recording in the usual manner. (See “Adjusting the input level” on page 20.)

Enabling dual recording

1. On the INPUT 1–2 screen, select the PHANTOM item. (See “Opening the INPUT 1-2 and INPUT 3-4 screens” on page 19.)

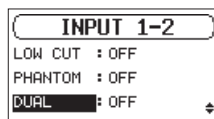

2. Set the dual recording mode.

Option	Meaning
OFF (default value)	This turns the dual recording function off.
–12dB	Record at 12dB lower than the input level.
LIMITER	Record while avoiding distortion when signals that are too loud are input suddenly.
AUTO LEVEL	Record while automatically increasing and decreasing the input level when it is too low or too high.

3. When finished, press the **STOP/HOME** [■] button to return to the Home Screen.

Starting dual recording

Press the **RECORD** [●] button to start dual recording.

During dual recording, the recording screen appears as follows.



When –12dB dual recording mode is selected

In the input source display area of the recording screen, the input levels of the current input source and the dual recording are shown.

Dual recording file names

Dual recording will create two files simultaneously.

The name of the second file created by dual recording has _D added to the file name of the ordinary recording.

TASCAM_0002_12.WAV

① ② ③

TASCAM_0002_12_D.WAV

① ② ③ ④

- ① Set with the **WORD** item on the **FILE NAME** screen
- ② Recording file project number
- ③ Assigned source channels
(12 → channels 1-2, 34 → channels 3-4)
- ④ Set with the **DUAL** item on the **INPUT 1–2** screen
(D → Dual recording)

4 – Recording

Recording duration

The table below shows maximum recording times by file format on SD/SDHC/SDXC cards of different capacities (in hours and minutes).

File format (recording setting)			SD/SDHC/SDXC card capacity			
			1 GB	4 GB	8 GB	32 GB
WAV/BWF 16-bit (STEREO)	44.1 kHz		1:34	6:17	12:35	50:23
	48 kHz		1:26	5:47	11:34	46:17
	96 kHz		00:43	2:53	5:47	23:08
WAV/BWF 24-bit (STEREO)	44.1 kHz		1:02	4:11	8:23	33:35
	48 kHz		00:57	3:51	7:42	30:51
	96 kHz		00:28	1:55	3:51	15:25
MP3 (STEREO/MONO)	32 kbps	44.1 kHz/48 kHz	69:26	277:00	555:00	2222:00
	64 kbps	44.1 kHz/48 kHz	34:43	138:00	277:00	1111:00
	96 kbps	44.1 kHz/48 kHz	23:08	92:35	185:00	740:00
	128 kbps	44.1 kHz/48 kHz	17:21	69:26	138:00	555:00
	192 kbps	44.1 kHz/48 kHz	11:34	46:17	92:35	370:00
	256 kbps	44.1 kHz/48 kHz	8:40	34:43	69:26	277:00
	320 kbps	44.1 kHz/48 kHz	6:56	27:46	55:33	222:00

- The recording times shown above are estimates. They might differ depending on the SD/SDHC/SDXC card in use.
- The recording times shown above are not continuous recording times, but rather they are the total possible recording times for the SD/SDHC/SDXC card.
- Recording automatically stops if recording time exceeds 24 hours.
- If recorded in mono WAV format, the maximum recording time will be double the figures above.
- When using dual/4-channel recording in WAV/BWF format, the maximum recording time will be about half the figures above.

5 – Working with Folders and Files (BROWSE screen)

You can manage audio files on SD cards in a folder structure.

After selecting a folder or file to work with on the **BROWSE** screen, you can open a pop-up menu for it.

In this menu, you can play and erase files, as well as add files to the playlist, for example. (See “Playlist” on page 29.)

NOTE

- *Using a computer to read the contents of SD cards, you can change the folder structure, edit the names of folders and files, and delete folders and files, for example.*
- *Making changes with a computer, however, could cause the order of the files to change when played back on the unit.*

Opening the BROWSE screen

Press the **BROWSE** button to open the **BROWSE** screen.

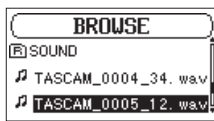

The contents of the folder that contains the file that was selected on the Home Screen before the **BROWSE** screen was opened appears on the display.

Screen navigation

On the **BROWSE** screen, folders and audio files appear in lists in the same way files are shown on a computer.

Folders can only be made to two levels.

When the **BROWSE** screen is open, use the **MULTI JOG** dial or **◀◀** and **▶▶** buttons to select a file or folder for use.

- Turn the **MULTI JOG** dial to select files and folders.
- When a folder is selected, press the **▶▶** button to show the contents of that folder.
- When a file or folder is selected, press the **◀◀** button to exit the currently open folder and go to a higher level in the folder structure.
- When a file or folder is selected, press the **MULTI JOG** dial to open the pop-up menu.

Icons on the BROWSE screen

The meanings of icons that appear on the **BROWSE** screen are as follows.

■ SOUND folder

The **SOUND** Folder is the highest (root) level folder in the hierarchy shown on the **BROWSE** screen.

■ Audio file

The  icon appears before the names of music files.

■ Folder

This icon shows folders that contain subfolders.

■ Folder

This icon shows folders that do not contain subfolders.

■ Open folder

The contents of the folder marked with this icon currently appear on the display.

Folder operations

Select the desired folder on the **BROWSE** screen and press the **MULTI JOG** dial to open the pop-up folder menu.



Turn the **MULTI JOG** dial to select the desired operation, and press the **MULTI JOG** dial to execute it as follows.

NOTE

*When a protected card is loaded in the unit, the **ALL DEL** item cannot be used. (See “SD card write protection switches” on page 18.)*

■ CANCEL

This cancels the operation for the selected folder and closes the folder menu.

■ PLAY

This plays the first file in the selected folder and returns to the Home Screen.

Regardless of the previous setting, the playback area is set to **FOLDER**, and this folder becomes the new playback area.

■ SELECT

This selects the first file in the selected folder, stops playback at its beginning and returns to the Home Screen.

Regardless of the previous setting, the playback area is set to **FOLDER**, and this folder becomes the new playback area. When recording, files are also created in this folder.

■ ALL DEL

A pop-up message appears to confirm that you want to delete all the files in the selected folder at once.

Turn the **MULTI JOG** dial to select **Yes**, and press the **MULTI JOG** dial to delete the files.

To cancel deletion, select **No**, and press the **MULTI JOG** dial to return to the **BROWSE** screen.



NOTE

You cannot erase read-only files and files that are not recognized by this unit.

5 – Working with Folders and Files (BROWSE screen)

File operations

Select the desired audio file on the BROWSE screen and press the **MULTI JOG** dial to open the pop-up file menu.



Turn the **MULTI JOG** dial to select the desired operation, and press the **MULTI JOG** dial to execute it as follows.

NOTE

*When a protected SD card is loaded in the unit, the **ADD LIST** and **FILE DEL** items cannot be used. (See “SD card write protection switches” on page 18.)*

■ CANCEL

This cancels the operation for the selected file and closes the file menu.

■ PLAY

The Home Screen reopens, and the selected file starts playing. The folder that contains this file becomes the current folder, and new recorded files will be saved in it. If the playback area has been set to **FOLDER**, this folder becomes the playback area.

■ INFO

Information (date/time, size) about the selected file appears. Press the **MULTI JOG** dial again or press the **STOP/HOME [■]** button to return to the BROWSE screen.

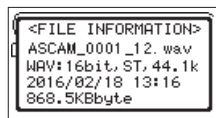

■ ADD LIST

Adds the selected file to the playlist. (See “Playlist” on page 29.)

■ FILE DEL

A message appears to confirm that you want to delete the file. Turn the **MULTI JOG** dial to select Yes, and press the **MULTI JOG** dial to delete the file.

To cancel deletion, select No, and press the **MULTI JOG** dial to return to the BROWSE screen.



Creating new folders

1. Select **NEW FOLDER** at the bottom of the folder list.



2. Press the **MULTI JOG** dial.

A pop-up appears to confirm that you want to create a new folder.



3. Turn the **MULTI JOG** dial to select Yes, and press the **MULTI JOG** dial to create the new folder.

To cancel folder creation, select No, and press the **MULTI JOG** dial to return to the BROWSE screen.

NOTE

*Since the unit supports only a two-level folder structure, **NEW FOLDER** does not appear in second-level folders. A newly created folder becomes the current one, and new recorded files are saved in this folder. If the playback area has been set to **FOLDER**, this folder becomes the playback area.*

5 – Working with Folders and Files (BROWSE screen)

Playlist

You can make a list of files for playback (playlist).

If you select **PLAYLIST** for the **AREA** item on the **PLAY SETTING** screen, you can set playback to just the files in the playlist.

Adding files to the playlist

1. Open the **BROWSE** screen. (See “Opening the BROWSE screen” on page 27.)
2. Select the file you want to add to the playlist, and press the **MULTI JOG** dial to open the pop-up file menu.
3. Select the **ADD LIST** item, and press the **MULTI JOG** dial.



This adds the selected file to the playlist.

4. Repeat steps 2–3 as necessary.
The files are numbered in the order that they are added.

Editing the playlist

You can view the playlist you have made on the **PLAYLIST** screen. You can also use this screen to play files and to edit the playlist.

1. Open the **BROWSE** screen. (See “Opening the BROWSE screen” on page 27.)
2. Use the ◀◀ button to move to the top folder level.



3. Select **PLAYLIST**, and press the ▶▶ button.
Open the **PLAYLIST** screen.



4. Select the file you want to change, and press the **MULTI JOG** dial.

This opens the playlist menu pop-up.



5. Select the desired item, and press the **MULTI JOG** dial.
The operations have the following functions.

Option	Meaning
CANCEL	No operation is used for the selected file.
PLAY	The display returns to the Home Screen, and the selected file starts playing.
ALL CLR	A message appears to confirm that you want to clear all files from the playlist. Turn the MULTI JOG dial to select Yes , and press the MULTI JOG dial to clear all the files. To cancel clearing the playlist, select No , and press the MULTI JOG dial to return to the BROWSE screen. For this operation, it does not matter which file you select in step 5. All the files are removed from the playlist, but they are not erased from the SD card.
DELETE	Remove the selected file from the playlist. The file is removed from the playlist, but it is not erased from the SD card.
MOVE	Select this to change the order of files in the playlist. In addition to the file name, the file number also appears highlighted in inverse. ● Turn the MULTI JOG to move the selected file to a different position in the playlist.  In the above example, the 4th file has been moved to the 3rd file position. ● Press the MULTI JOG dial. The file is moved and the PLAYLIST screen reopens.

6 – Playback

This unit can handle audio files of the following formats.

- BWF: 44.1/48/96kHz, 16/24 bit
- WAV: 44.1/48/96kHz, 16/24-bit
- MP3: 44.1/48kHz, 32–320kbps

On the Home Screen, you can turn the **MULTI JOG** dial to select the playback file. The files that you can select are determined by the playback area setting. Limiting the playback area makes file selection easier when you have numerous files on the SD card.

On the **PLAY SETTING** screen, you can select all files, the current folder or the playlist as the playback area. You can also use the **BROWSE** screen to set a folder as the playback area.

NOTE

*On the **BROWSE** screen, regardless of the playback area setting, you can select any file on the card that you want.*

Opening the PLAY SETTING screen

Press the **PLAY SETTINGS** button to open the **PLAY SETTING** screen.

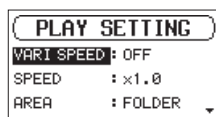

When the **PLAY SETTING** screen is open, press the **PLAY SETTINGS** button to return to the Home Screen.

Playback area

The group of playback files that you can select on the Home Screen is called the “playback area”.

Limiting the playback area makes playback file selection easier when you have numerous files on the SD card.

Setting the playback area

Use **AREA** item on the **PLAY SETTING** screen to set the playback area.

1. Select the **AREA** item on the **PLAY SETTING** screen. (See “Opening the **PLAY SETTING** screen” on page 30.)

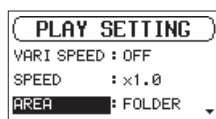

2. Set the desired playback area.

Option	Meaning
ALL FILES	Set the playback area as all files in the SOUND folder on the SD card.
FOLDER (default)	Play all the files in the folder that contains the currently selected file.
PLAYLIST	Play the files in the playlist. (See “Playlist” on page 29.) If there is no playlist, a No PLAYLIST pop-up appears.

3. When finished, press the **STOP/HOME [■]** button to return to the Home Screen.

NOTE

The current playback area setting appears in the upper left of the Home Screen.

Playback area indicator



Using the BROWSE screen to select the playback area folder (1)

Regardless of the current playback area, if you select a folder on the **BROWSE** screen, the playback area changes to the selected folder.

1. Open the **BROWSE** screen and select the folder you want to set as the playback area. (See “Opening the **BROWSE** screen” on page 27.) and (See “Screen navigation” on page 27.).
2. Press the **MULTI JOG** dial to open the folder pop-up menu.
3. Select the **SELECT** item, and press the **MULTI JOG** dial.



The Home Screen reopens, the first file in the folder is selected, and the unit is stopped.

Regardless of the previous setting, the playback area is set to **FOLDER**, and this folder becomes the new playback area. This folder becomes the current folder, and new recorded files will be saved in this folder.

Using the BROWSE screen to select the playback area folder (2)

When the playback area is set to **FOLDER**, if you select a file on the **BROWSE** screen, the folder that contains the selected file becomes the playback area.

1. Open the **BROWSE** screen and select the desired file. (See “Opening the **BROWSE** screen” on page 27.) and (See “Screen navigation” on page 27.).
2. Press the **MULTI JOG** dial to open the folder pop-up menu.
3. Select the **PLAY** item, and press the **MULTI JOG** dial.

The Home Screen reopens, and the selected file starts playing. This folder becomes the current folder, and new recorded files will be saved in this folder.

When set to **FOLDER**, the folder that contains this file becomes the playback area.

Playing files

When the Home Screen is open and playback is stopped, press the **PLAY** [▶] button to start playback.

NOTE

- Only files in the playback area that is currently set can be selected for playback.
- You can also choose files for playback by name on the **BROWSE** screen.

Pausing playback

When the Home Screen is open and a file is playing back, press the **STOP/HOME** [■] button to pause playback at the current position.

Press the **PLAY** [▶] button again to restart playback from that position.

Stopping playback

When the Home Screen is open and a file is playing back, press the **STOP/HOME** [■] button to pause playback, and press the **STOP/HOME** [■] button again to return to the beginning of the file.

Rewinding and fast-forwarding (search)

When the Home Screen is open and a file is playing back or stopped, press and hold the ◀◀ or ▶▶ button to search backward or forward.

NOTE

Press and hold the ◀◀ or ▶▶ button to accelerate the search speed.

Selecting files for playback (skipping)

On the Home Screen, you can turn the **MULTI JOG** dial to select the file you want to play.

If you turn the **MULTI JOG** dial counterclockwise in the middle of file playback, it will return to the beginning of that file.

If you turn the **MULTI JOG** dial counterclockwise when at the beginning of a file, the playback position will skip to the beginning of the file before it in order.

If you turn the **MULTI JOG** dial clockwise when located at the beginning or middle of a file, the playback position will skip to the beginning of the next file in order.

NOTE

- Only files in the playback area that is currently set can be selected for playback.
- The file name, file number and other file information for the currently playing file appear on the display.
- The 8 icon appears on the display when playback is stopped at the beginning of a file. The 9 icon appears when playback is paused in the middle of a file.
- Turn the **MULTI JOG** dial as many times as necessary if you want to move between files.

Changing the playback speed (VARI SPEED)

The unit features a variable speed function that changes the playback speed without changing its pitch.

CAUTION

The variable speed function cannot be used on files recorded with 96kHz sampling frequency. For these files, the **SPD** will appear and the playback speed setting can still be changed.

This setting will not affect these files, but it will become active if a 44.1/48kHz file is loaded.

1. Select the **VARI SPEED** item on the **PLAY SETTING** screen. (See “Opening the **PLAY SETTING** screen” on page 30.)

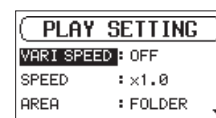

2. Turn the variable speed function on.
Options: OFF (default), ON
3. Select the **SPEED** item on the **PLAY SETTING** screen.

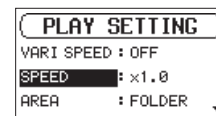

4. Change the speed setting.
Options: x0.5 – x1.5 (in x0.1 increments, x1.0 default)
5. When finished, press the **PLAY SETTING** button to return to the Home Screen.

6 – Playback

Setting the play mode

Follow these procedures to set the play mode.

1. Select the **PLAY MODE** item on the **PLAY SETTING** screen. (See “Opening the **PLAY SETTING** screen” on page 30.)

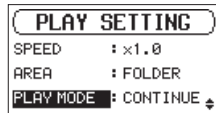

2. Set the play mode.

Option	Meaning
CONTINUE (default)	All files in the playback area are played in sequence one time.
SINGLE	The selected file is played once without repeating. The  icon appears on the Home Screen.

3. Press the **STOP/HOME [■]** button to return to the Home Screen and start playback.

NOTE

*By combining this with the **REPEAT** item on the **PLAY SETTING** screen, you can repeatedly play one file or multiple files within a designated area.*

Repeating playback

Follow these procedures to set the repeat playback function.

1. Select the **REPEAT** item on the **PLAY SETTING** screen. (See “Opening the **PLAY SETTING** screen” on page 30.)

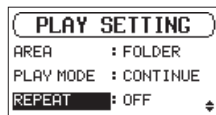

2. Turn the repeat function on or off.
Options: OFF (default), ON
3. Press the **STOP/HOME [■]** button to return to the Home Screen and start playback.

NOTE

*By combining this with the **PLAY MODE** item on the **PLAY SETTING** screen, you can repeatedly play one file or multiple files within a designated area.*

Jumping back a few seconds and replaying (jumpback playback)

Press the **PLAY [▶]** button during playback to move back a few seconds (adjustable) and restart playback (jumpback playback).

If you find a favorite passage of music or lyrics during playback, press the **PLAY [▶]** button to go back a few seconds and replay that passage.

You can set the jumpback time with the **JUMPBACK** item.

1. Select the **JUMPBACK** item on the **PLAY SETTING** screen. (See “Opening the **PLAY SETTING** screen” on page 30.)



2. Set how far to go back when using the jumpback playback function.
Options: OFF (0 seconds), 1 SEC. – 10 SEC. (1–10 seconds), 20 SEC., 30 SEC. (default: 3 SEC.)
3. When finished, press the **PLAY SETTING** button to return to the Home Screen.

7 – Settings and Information

Dividing a selected file manually (DIVIDE)

A recorded file can be divided into two at a specified position.

CAUTION

- MP3 files cannot be divided.
- If the SD card has insufficient open space, division might not be possible.
- Division is not possible if the file name would become more than 200 characters long.
- Division is not possible if a file that already exists has the same name as the name that would be given to a new file created by division.
- The original file does not remain after division.

1. Turn the **MULTI JOG** dial or use the **BROWSE** screen to select the file you want to divide.
2. While the Home Screen is open when stopped, press the **MENU** button to show the **MENU** screen.
3. Select the **DIVIDE** item, and press the **MULTI JOG** dial. The **DIVIDE** screen appears.

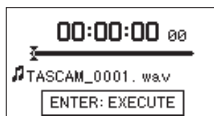

4. Use the following controls to set the division (**DIVIDE**) point.
 - PLAY** [▶] button: play
 - STOP/HOME** [■] button: stop
 - ◀◀/▶▶ buttons: move to mark positions
 - Turn **MULTI JOG** dial: adjust division point precisely
5. After setting the division point, press the **MULTI JOG** dial. The following pop-up window appears.

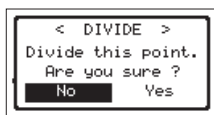

6. Turn the **MULTI JOG** dial to select **Yes**, and press the **MULTI JOG** dial to divide the file.
Select **No**, and press the **MULTI JOG** dial to return to the **DIVIDE** screen without dividing the file.

NOTE

After dividing a file, two new files with “a” and “b” added to the end of the original file name are created.

Example of files recorded in 4-channel mode

File names before division

TASCAM_0003_12.wav

TASCAM_0003_34.wav

File names after division

TASCAM_0003_12a.wav (part before division point)

TASCAM_0003_34a.wav (part before division point)

TASCAM_0003_12b.wav (part after division point)

TASCAM_0003_34b.wav (part after division point)

TIP

Add marks during recording at positions where you want to divide a file. (See “Using mark functions” on page 24.)

Setting the file name format

You can select the format of names given to files recorded by this unit.

1. Select the **FILE NAME** item on the **MENU** screen, and press the **MULTI JOG** dial. (See “Menu operation procedures” on page 14.)

The **FILE NAME** screen appears.



2. Select the **TYPE** item and set the file name format.

Options	Meaning
WORD (default)	The 6-character file name set with the WORD item is used as the file name. Example: TASCAM_0001_12.wav
DATE	The date is used as the file name (in yymmdd format). Example: 110101_0001.wav

NOTE

The date is set using the unit's internal clock. (See “Setting the date and time” on page 17.)

Setting the WORD item

On the **WORD** item, press the **MULTI JOG** dial and move the cursor. Then, turn the **MULTI JOG** dial to set the character.

In addition to the alphabet and numbers, the following characters can be used:

! # \$ % & ' () + , - . : ; = @ [] ^ _ ` { } ~

Resetting the count (COUNT INIT)

On the **COUNT INIT** item, press the **MULTI JOG** dial to reset the count. The numbers added to file names (characters set by **WORD**) created after this will restart from “0001”.

7 – Settings and Information

Show media information

Use the **MEDIA INFO** screen to view information about the SD card loaded in the unit.

Follow the procedures below to view the **MEDIA INFO** screen.

1. Select the **MEDIA INFO** item on the **MENU** screen, and press the **MULTI JOG** dial. (See “Menu operation procedures” on page 14.)

The **MEDIA INFO** screen opens.

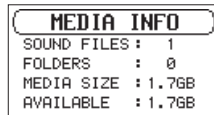

SOUND FILES

This shows the number of playable files in the **SOUND** folder.

FOLDERS

This shows the total number of folders in the **SOUND** folder.

MEDIA SIZE

This shows the total SD card capacity.

AVAILABLE/USED

Shows the amount of unused/used capacity on the SD card.

Press the **◀** or **▶** button to switch between **AVAILABLE** and **USED**.

2. When finished, press the **STOP/HOME** [■] button to return to the Home Screen.

Restoring factory default settings

You can restore the various settings stored in the backup memory of the unit to their factory default values.

1. Select the **INITIALIZE** item on the **MENU** screen, and press the **MULTI JOG** dial.

A confirmation pop-up message appears.

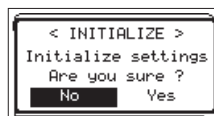

2. Turn the **MULTI JOG** dial to select **Yes**, and press the **MULTI JOG** dial to start initializing.

To cancel initializing, select **No**, and press the **MULTI JOG** dial.

Formatting SD cards

Follow this procedure to format an SD card.

Formatting erases all audio files on the SD card and automatically creates new “**SOUND**” and “**UTILITY**” folders as well as a “**dr-1.sys**” file.

CAUTION

When formatting, the unit should be operating using the included AC adapter (TASCAM PS-P1220E) or batteries with sufficient remaining power. If the power fails during formatting, the formatting may not occur correctly.

1. Select the **SD FORMAT** item on the **MENU** screen, and press the **MULTI JOG** dial. (See “Menu operation procedures” on page 14.)

The following pop-up message will appear for formatting method selection.

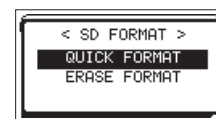

2. Set the formatting method.

Option	Meaning
QUICK FORMAT	Execute quick formatting.
ERASE FORMAT	Erase and format the card.

NOTE

- *Using the erase and format option might restore an SD card that has decreased writing performance due to repeated use.*
 - *Erasing and formatting checks the memory for errors while formatting, so it takes more time than quick formatting.*
3. Press the **MULTI JOG** dial to open a pop-up confirmation message.

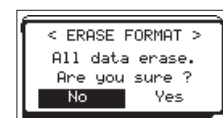
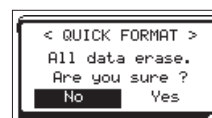

QUICK FORMAT selected ERASE FORMAT selected

4. Turn the **MULTI JOG** dial to select **Yes**, and press the **MULTI JOG** dial to start formatting.

To cancel formatting, select **No**, and press the **MULTI JOG** dial to return to the **MENU** screen.

Setting the output level

If sound distorts from an output destination device at maximum output level, you can set this function to lower the output level to stop the distortion.

1. Select the **OUTPUT LEVEL** item on the **MENU** screen, and press the **MULTI JOG** dial. (See “Menu operation procedures” on page 14.)

The **OUTPUT LEVEL** screen opens.

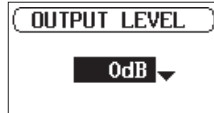

2. Turn the **MULTI JOG** dial to set the output level.
Options: 0dB (default) – –14dB (in 1dB increments)
3. When finished, press the **STOP/HOME [■]** button to return to the Home Screen.

Make system settings

You can change various settings on the **MENU** screen to optimize the device for your use conditions and other requirements. (See “Menu operation procedures” on page 14.)

Setting the type of batteries

Use the **BATTERY TYPE** item to set the type of batteries used. This setting is used to show the amount of remaining battery charge and determine if the unit has enough power for normal operation.

Options: **ALKALI** (alkaline, default), **Ni-MH** (nickel-metal hydride), **LITHIUM** (lithium)

Set the automatic power saving function

Use the **AUTO PWR SAVE** item to set the amount of time from when the unit last operated or was used until the unit automatically turns off.

Options: **OFF** (unit does not automatically turn off), **3min**, **5min**, **10min**, **30min** (default)

Setting the backlight

Use **BACKLIGHT** to set the time until the backlight automatically turns off after the last operation.

Options: **OFF** (turned off), **5 sec** (default), **10 sec**, **15 sec**, **30 sec**, **ALWAYS** (always on)

Adjusting the display contrast

Use **CONTRAST** to adjust the display contrast.

Options: **1 – 20** (default: **5**)

Viewing system information

The **VERSION** screen shows information about the unit's system firmware version.

1. Select the **VERSION** item on the **MENU** screen, and press the **MULTI JOG** dial. (See “Menu operation procedures” on page 14.)

Information about the current system firmware version is shown on the **VERSION** screen.



2. When finished, press the **STOP/HOME [■]** button to return to the Home Screen.

8 – Using the REMOTE jack

This unit has a **REMOTE** jack. Connect a TASCAM RC-3F footswitch or TASCAM RC-10 wired remote control (both sold separately) here to enable remote operation of this unit.

Using a footswitch (TASCAM RC-3F)

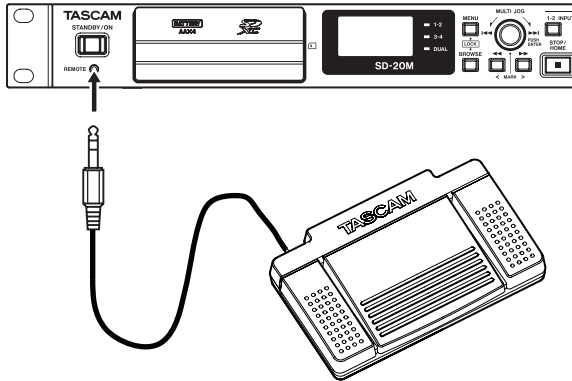

TASCAM RC-3F (sold separately)

Setting up the footswitch

1. Select the **REMOTE** item on the **MENU** screen, and press the **MULTI JOG** dial. (See “Menu operation procedures” on page 14.)
The **REMOTE** screen appears.

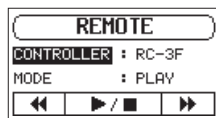

2. Set the **CONTROLLER** item to RC-3F (default).
3. Select the **MODE** item and set the footswitch mode.
Options: **PLAY** (default), **RECORD1**, **RECORD2**, **MINUTES**

MODE	Footswitch		
	L	C	R
PLAY	◀◀	▶/■	▶▶
RECORD1	■	●/	▶▶
RECORD2	■	●/	MARK
MINUTES	⏮	▶/■	SPEED

MARK: mark function

⏮: Jumpback playback

SPEED: Variable speed function on/off

(All functions are the same as the main unit.)

4. When finished, press the **STOP/HOME [■]** button to return to the Home Screen.

Using the footswitch

Press the pedals of the footswitch to use the operations assigned to them on the **REMOTE** screen.

Using a remote control (TASCAM RC-10)

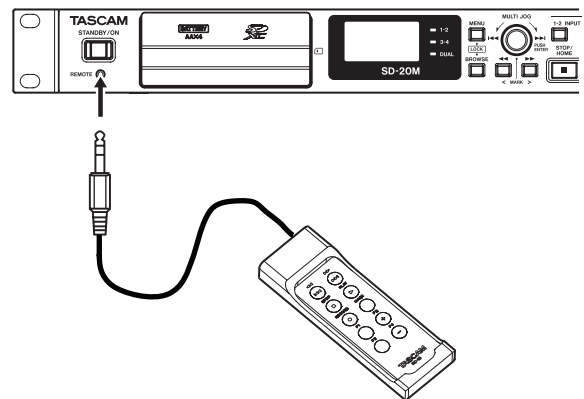

TASCAM RC-10 (sold separately)

Setting up a wired remote control

1. Select the **REMOTE** item on the **MENU** screen, and press the **MULTI JOG** dial. (See “Menu operation procedures” on page 14.)
The **REMOTE** screen appears.
2. Set the **CONTROLLER** item to RC-10 (default: RC-3F).

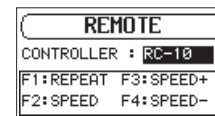

Function button details

Function buttons			
F1	F2	F3	F4
REPEAT	SPEED*	SPEED+	SPEED-

*Speed change (variable speed function on/off)

3. When finished, press the **STOP/HOME [■]** button to return to the Home Screen.

Using the wired remote control

Press the function (**F1–F4**) buttons on the wired remote control to use the operations assigned to them on the **REMOTE** screen.

9 – Messages

The following is a list of the pop-up messages.

These might appear on the SD-20M under certain conditions. Refer to this list if one of these pop-up messages appears and you want to check the meaning or determine a proper response.

Message	Meaning and response
Write Error REC continues	Writing to the media timed out. Noise has occurred in the audio. A BOF mark has been added at the location of the noise.
Can't Divide	The selected division point is not suitable. (Located at the beginning or end of a file.)
Card Error	The card could not be recognized properly. Change the card.
Card Full	The card has no remaining space. Erase unnecessary files or move them to a computer to make open space.
CARD SLOW Check BOF Mark	This appears when recording has stopped after a Write Error REC continues message. Since the writing performance of the SD card has decreased, use the Erase Format function on it or change to a different SD card. Please check the file's audio around the time of the BOF mark for the presence of any noise. (See "Moving to a mark position" on page 24.)
Current File MP3	MP3 files cannot be divided.
Dup File Name	The DIVIDE function would cause the file name to be the same as that of an existing file in the same folder. The DIVIDE function adds "a" or "b" to the end of the file name. Before choosing the DIVIDE function, use a computer to change the file name.
File Full	The total number of folders and files exceeds 5000. Erase unnecessary folders and files or move them to a computer.
File Name ERR	The DIVIDE function would cause the file name to exceed 200 characters. The DIVIDE function adds "a" or "b" to the end of the file name. Before choosing the DIVIDE function, use a computer and edit the file name to less than 198 characters.
File Not Found	A file added to the playlist cannot be found or could be damaged. Please check that file.
File Not Found PLAYLIST	A file in the Playlist cannot be found. Please confirm that the file is still in the SOUND folder.
File Protected	The file is read only and cannot be erased.
Format Error Format CARD	The card is not formatted properly or the card is broken. This message also appears if you FAT formatted the card using a computer and if an unformatted card is inserted in the unit. Always use the SD-20M to format cards to be used with it. Change the card or press the MULTI JOG dial while this message is being shown to FAT format the card. CAUTION: Execution of FAT formatting erases all data currently on the card.
Invalid Card Change Card	Something might be wrong with the card. Change the card.

Message	Meaning and response
Invalid SysFile Make Sys File	The system file required to operate this unit is invalid. When this message appears, press the MULTI JOG dial to automatically create a new system file.
Max File Size	The file is probably larger than the designated size. The recording time might also exceed 24 hours.
MBR Error Init CARD	The card is not formatted properly or the card is broken. Change the card or press the MULTI JOG dial while this message is being shown to FAT format the card.
No Card	No SD card is loaded in the unit. Insert a recordable SD card.
No SOUND File	There is no playback file, so DIVIDE cannot be executed.
No PB File	There is no file that can be played back. The file might be damaged.
No PLAYLIST	No files have been added to the Playlist. Add a file to the Playlist or change the play mode to something besides PLAYLIST.
Non-Supported	The audio file is not a supported format. Please see "6 – Playback" on page 30 for file formats that this unit can use.
PLAYLIST Full	The playlist is full. You cannot add more than 99 files to the Playlist.
Write Timeout	Writing to the card timed out. Backup files on the card to a computer, and format the card.
Can't Save Data	If any of these errors occurs, turn the unit off and restart it.
Device Error	
File Error	
Not Continued	
Player Error	
Remote Cmd	
Remote Rx	
Writing Failed	
Sys Rom Err	
System Err 50	
System Error 1	
System Error 2	
System Error 3	
System Error 4	
System Error 5	
System Error 6	
System Error 7	
System Error 8	
System Error 9	

10 – Troubleshooting

If you are having trouble with the operation of this unit, please try the following before seeking repair. If these measures do not solve the problem, please contact the store where you bought the unit or TEAC customer support.

■ The unit will not turn on.

- Confirm that the batteries are not dead.
- Confirm that the batteries are installed with the correct ⊕/⊖ orientation.
- Confirm that the included AC adapter (TASCAM PS-P1220E) is securely connected to both the outlet and the unit power connector.

■ The unit turns off automatically.

Is the automatic power saving function on?(See “Set the automatic power saving function” on page 35.)

- Since this unit complies with the European Standby Power Regulations (ErP), the automatic power saving function operates regardless of whether the unit is being powered by an AC adapter or batteries. If you do not want to use the automatic power saving function, set it to “OFF”. (The factory default setting is “30min”.)

■ The SD card is not recognized.

- Confirm that the SD card is inserted completely.

■ Playback is not possible.

- If you are trying to play a WAV file, confirm that the sampling frequency is supported by this unit.
- If you are trying to play an MP3 file, confirm that the bit rate is supported by this unit.

■ No sound is output.

- Check connections with the monitoring system again. Check the volume of the amplifier as well.

■ Recording is not possible.

- Check connections with other equipment again.
- Check the input settings again.
- Confirm that the input level is not too low.
- Confirm that the SD card is not full.
- Confirm that the number of files has not reached the maximum that the unit can handle.
- Check the audio source level.

■ The input level is low.

- Confirm that the input level setting is not too low.
- Confirm that the output level of any connected device is not too low.

■ The sound I am trying to record sounds distorted.

- Confirm that the input level setting is not too high.

■ The playback sounds unnatural.

- Confirm that the playback speed has not been changed.

■ I cannot erase a file.

- Confirm that you are not trying to erase a write-protected file that has been copied from a computer.

Ratings

■ Recording media

SD card (64 MB–2 GB)
SDHC card (4 GB–32 GB)
SDXC card (48 GB–128GB)

■ Recording/playback formats

BWF: 44.1/48/96kHz, 16/24 bit
WAV: 44.1/48/96kHz, 16/24-bit
MP3: 44.1/48 kHz, 32/64/96/128/192/256/320 kbps

■ Number of channels

4 channels (stereo × 2)

Input/output ratings

Analog audio input and output ratings

■ MIC/LINE INPUT 1/2 jacks (balanced, only XLR support phantom power)

Connectors

XLR-3-31 (1: GND, 2: HOT, 3: COLD)
6.3mm (1/4") standard TRS jacks (Tip: HOT, Ring: COLD, Sleeve: GND)

Set to MIC (support phantom power)

Input impedance: 2.7 k Ω
Maximum input level: 0 dBu (Gain: LOW)
Minimum input level: –67 dBu (Gain: HIGH)

Set to LINE

Input impedance: 10 k Ω or more
Nominal input level: +4 dBu
Maximum input level: +20 dBu
Minimum input level: –12 dBu

■ INPUT 3/L and 4/R jacks (UNBALANCED)

Connectors: RCA pin jacks
Input impedance: 10 k Ω or more
Nominal input level: –10 dBV
Maximum input level: +6 dBV
Minimum input level: –26 dBV

■ OUTPUT jacks

Connectors: RCA pin jacks
Nominal output level: –10 dBV
Maximum output level: +6 dBV
Output impedance: 200 Ω

■ PHONES jack

Connector: 6.3mm (1/4") standard stereo jack
Maximum output: 20 mW + 20 mW (when into 32 Ω , distortion 0.1%)

Control input/output

■ REMOTE jack

Connector: 2.5mm TRS jack

Audio performance

■ Frequency response

20-20 kHz +1/–3 dB
(INPUT 1-2 to OUTPUT, Fs 44.1/48kHz, JEITA*)
20-40 kHz +1/–3 dB
(INPUT 1-2 to OUTPUT, Fs 96kHz, JEITA*)

■ Distortion

0.01% or less (INPUT 1-2 to OUTPUT, Fs 44.1/48/96kHz, JEITA*)

■ S/N ratio

100 dB or more (INPUT 1-2 to OUTPUT, Fs 44.1/48/96kHz, JEITA*)

*Based on JEITA CP-2150

General

■ Power

Dedicated AC adapter (TASCAM PS-P1220E) × 1
4 AA batteries (alkaline, NiMH or lithium)

■ Power consumption

5 W (maximum)

■ Current consumption

1 A (maximum)

11 – Specifications

■ Battery operation time (continuous operation)

- Using alkaline batteries (EVOLTA)

Use conditions	Approximate operation time (in hours and minutes)
1-2 channels/line input Recording 2 channels, 44.1kHz/16-bit WAV	2:45
1-2 channels/mic input Phantom power used Recording 2 channels, 44.1kHz/16-bit WAV	1:45
1-2 channels/mic input Phantom power unused 3-4 channels/line input Recording 4 channels, 44.1kHz/16-bit WAV	1:15

- Using NiMH batteries (eneloop)

Use conditions	Approximate operation time (in hours and minutes)
1-2 channels/line input Recording 2 channels, 44.1kHz/16-bit WAV	3:45
1-2 channels/mic input Phantom power used Recording 2 channels, 44.1kHz/16-bit WAV	2:30
1-2 channels/mic input Phantom power unused 3-4 channels/line input Recording 4 channels, 44.1kHz/16-bit WAV	1:45

- Using lithium batteries (Energizer Ultimate Lithium)

Use conditions	Approximate operation time (in hours and minutes)
1-2 channels/line input Recording 2 channels, 44.1kHz/16-bit WAV	7:00
1-2 channels/mic input Phantom power used Recording 2 channels, 44.1kHz/16-bit WAV	5:15
1-2 channels/mic input Phantom power unused 3-4 channels/line input Recording 4 channels, 44.1kHz/16-bit WAV	5:00

■ Dimensions

482.6 × 45 × 299.6 mm (width × height × depth)

■ Weight

2.8 kg (including batteries)/2.7 kg (not including batteries)

■ Operating temperature range

5°C–35°C (41°F–95°F)

Dimensional drawings

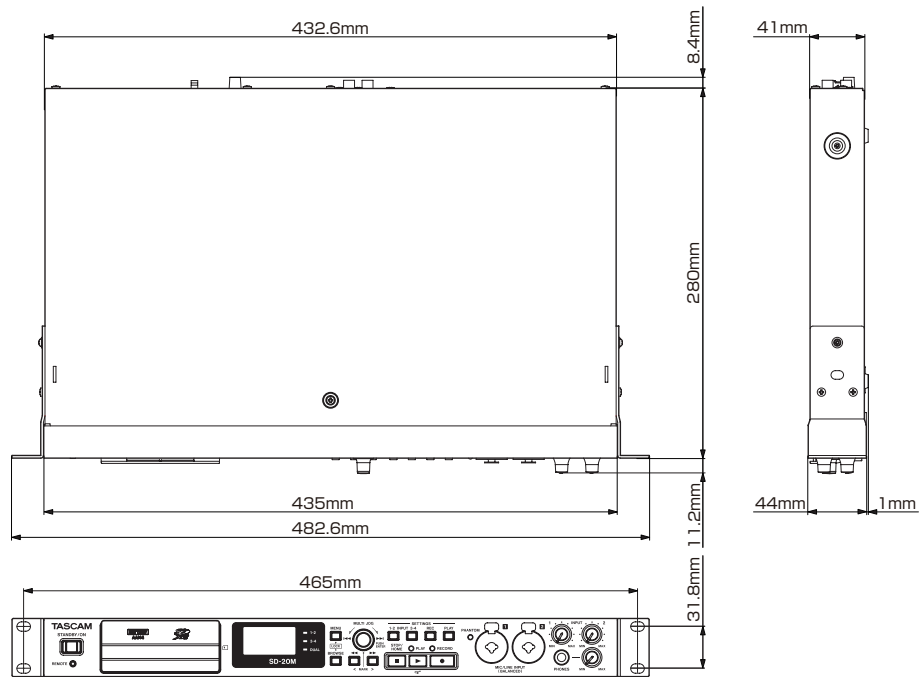

- Illustrations in this manual might differ in part from the actual product.
- Specifications and external appearance might be changed without notification to improve the product.

WARRANTY

< In the United States >

This warranty gives you specific legal rights and you may also have other rights which vary from state to state. This warranty is only valid within the country the unit was originally purchased.

WHAT IS AND IS NOT COVERED

Except as specified below, this warranty covers all defects in materials and workmanship in this product. The following are not covered by the warranty:

1. **Damage to or deterioration of the external cabinet.**
2. **Damages resulting from accident, misuse, abuse or neglect.**
3. **Damage resulting from failure to perform basic daily maintenance and/or calibration or otherwise resulting from failure to follow instructions contained in your owner's manual.**
4. **Damage occurring during shipment of the product. (Claims must be presented to the carrier)**
5. **Damage resulting from repair or attempted repair by anyone other than TEAC or an authorized TASCAM service station.**
6. **Damage resulting from causes other than product defects, including lack of technical skill, competence, or experience of the user.**
7. **Damage to any unit which has been altered or on which the serial number has been defaced, modified or is missing.**

WHO MAY ENFORCE THE WARRANTY

This warranty may be enforced only by the original purchaser. This warranty is not valid if the product was purchased through an unauthorized dealer.

LENGTH OF WARRANTY

All parts except heads and disk drives are warranted for one (1) year from the date of original purchase. Heads and disk drives are warranted to ninety (90) days from date of original purchase. Labor is warranted for ninety (90) days from date of original purchase.

WHAT WE WILL PAY FOR

We will pay all labor and material expenses for items covered by the warranty. Payment of shipping charges is discussed in the next section of this warranty.

HOW YOU CAN GET WARRANTY SERVICE

Your unit must be serviced by an authorized TASCAM service station in the United States. (This warranty is not enforceable outside the U.S.) If you are unable to locate an authorized TASCAM service station in your area, please contact us. We either will refer you to an authorized service station or instruct you to return the unit to the factory. Whenever warranty service is required, you must present a copy of the original dated sales receipt from an Authorized TASCAM Dealer.

You must pay any shipping charges if it is necessary to ship the product to service. However, if the necessary repairs are covered by the warranty, we will pay return surface shipping charges to any destination within the United States.

LIMITATION OF IMPLIED WARRANTIES

Any implied warranties, INCLUDING WARRANTIES OF MERCHANTABILITY AND FITNESS FOR A PARTICULAR PURPOSE, are limited in duration to the length of this warranty.

EXCLUSION OF DAMAGES

TEAC's liability for any defective product is limited to repair or replacement of the product, at TEAC's option. TEAC shall not be liable for:

1. **Damages based upon inconvenience, loss of use of the product, loss of time interrupted operation or commercial loss; or**
2. **Any other damages, whether incidental, consequential or otherwise.**

Some states do not allow limitations on how long an implied warranty lasts and/or do not allow the exclusion or limitation of incidental or consequential damages, so the above limitations and exclusions may not apply to you.

To locate an Authorized Service Center in Your Area

CALL 1-800-447-8322

< Europe >

This product is subject to the legal warranty regulations of the country of purchase. In case of a defect or a problem, please contact the dealer where you bought the product.

Ce produit est sujet aux réglementations concernant la garantie légale dans le pays d'achat. En cas de défaut ou de problème, veuillez contacter le revendeur chez qui vous avez acheté le produit.

Dieses Gerät unterliegt den gesetzlichen Gewährleistungsbestimmungen des Landes, in dem es erworben wurde. Bitte wenden Sie sich im Gewährleistungsfall an den Händler, bei dem sie das Gerät erworben haben.

Questo apparecchio è conforme alle norme sulla garanzia vigenti nel rispettivo Paese in cui esso è stato acquistato. Si prega di rivolgersi al proprio commerciante, presso il quale è stato acquistato l'apparecchio, nel caso in cui si voglia richiedere una prestazione in garanzia.

Las condiciones de garantía de este aparato están sujetas a las disposiciones legales sobre garantía del país en el que ha sido adquirido. En caso de garantía, debe dirigirse al establecimiento donde adquirió el aparato.

< In other countries/areas >

This warranty gives you specific legal rights, and you may also have other rights that vary by country, state or province.

If you have a warranty claim or request, please contact the dealer where you bought the product.

该保证书赋予了顾客特定的合法权利，并且因国家、州或省等地域的不同，顾客可能拥有其他权利。如需申请或要求保修，请与购买本产品的销售店进行联系。

If you require repair services for your TASCAM equipment, please contact the dealer where the product was purchased from or the TASCAM Distributor in your country. A list of TASCAM Distributors can be found on our website at: <http://teac-global.com/>

TASCAM

TEAC CORPORATION

Phone: +81-42-356-9143

1-47 Ochiai, Tama-shi, Tokyo 206-8530 Japan

<http://tascam.jp/>

TEAC AMERICA, INC.

Phone: +1-323-726-0303

1834 Gage Road, Montebello, California 90640 USA

<http://tascam.com/>

TEAC MEXICO, S.A. de C.V.

Phone: +52-55-5010-6000

Río Churubusco 364, Colonia Del Carmen, Delegación Coyoacán, CP 04100, México DF, México

<http://teacmexico.net/>

TEAC UK Ltd.

Phone: +44-8451-302511

2 Huxley Road, Surrey Research Park, Guildford, GU2 7RE, United Kingdom

<http://tascam.eu/>

TEAC EUROPE GmbH

Phone: +49-611-71580

Bahnstrasse 12, 65205 Wiesbaden-Erbenheim, Germany

<http://tascam.eu/>

TEAC SALES & TRADING(SHENZHEN) CO., LTD

Phone: +86-755-88311561~2

Room 817, Block A, Hailrun Complex, 6021 Shennan Blvd., Futian District, Shenzhen 518040, China

<http://tascam.cn/>

Printed in China

WARRANTY

Model/Modèle/Modell
Modello/Modelo/型号

SD-20M

Owner's name/Nom du possesseur/Name des Eigentümers
Nome del proprietario/Nombre del propietario/顾客姓名

Serial No./Série/Seriennummer
Número de serie/Número de serie/序列号

Sample

Address/Adresse/Adresse
Indirizzo/Dirección/顾客地址

Date of purchase/Date de l'achat/Datum des Kaufs
Data de la compra/Fecha de compra/购买日期

Dealer's name/Nom du détaillant/Name des Händlers
Nome del commerciante/Nombre del establecimiento/销售店名

TASCAM
<http://teac-global.com/>

Dealer's address/Adresse du détaillant/Adresse des Händlers
Indirizzo del commerciante/Dirección del establecimiento/销售店地址