



NEXT GEN *PCS*[™]

POWER CONDITIONING SYSTEM



User Manual

120 and 208/230 Volt Models

120V Firmware Revision 1.40 and higher
208/230V Firmware Revision 1.0 and higher
Software Revision 2.7 and higher



205 Westwood Ave, Long Branch, NJ 07740
Phone: 866-94 BOARDS (26273) / (732)-222-1511
Fax: (732)-222-7088 | E-mail: sales@touchboards.com



ADVANCED SERIES MODE™	ECOMMANDCENTER™	FLATPAK™	MULTI-STAGE™	SURGE + DIAGNOSTIC™
AXESS™	ELIMINATOR SERIES™	ICE™	NEXT GEN™	SURGE + PDU™
CERVELLA™	EMPOWER™	IMPEDANCE TOLERANT®	PCS™	SURGE ELIMINATION™
COUVS®	ENERGY INTELLIGENCE™	INRUSH CURRENT™	POWERFRAME™	SURGEX®
DEFENDER SERIES™	ENVISION™	ELIMINATION™	REMOTE PORTAL™	
DIGITAL QC™	ESP™	MULTIPAK™	SERIES MODE®	

This product may be covered by one or more claims of the following patents or published patent application:

U.S. Patent Nos: RE39,466; 4,870,528; 4,870,534; 5,136,455; 6,040,969; 6,728,089; 6,744,613; 6,947,266; 7,068,487; 7,184,252; 7,511,934; 7,541,696; and 7,551,412; 8,482,885; 8,520,349; 8,547,672; and 8,614,866

U.S. Patent Application Publication Nos.: 2012/0221161; 2013/0073232; 2012/0265361; 2013/0073060; 2013/0258538; and 2014/0005963







Canadian Patent No. 1,332,439; 1,333,191; 2,461,332 and 2,511,695

I. <u>NEXT GEN PCS PRODUCT OVERVIEW</u>	<u>2</u>
II. <u>INSTALLATION INSTRUCTIONS</u>	<u>3</u>
1. Next Gen PCS PC Filter Installation.....	3
2. Next Gen PCS Data Interface Kit – PC and Driver Installation.....	6
3. Next Gen Data Interface Kit – Diagnostic Software Installation.....	6
III. <u>Hardware</u>	<u>9</u>
1. Next Gen PCS Filter.....	9
a. LCD Event Monitor.....	9
b. Clearing Memory.....	11
2. Next Gen PCS Data Interface Cable.....	11
a. Overview.....	11
b. Instructions for Data Retrieval.....	12
IV. <u>Diagnostic Software</u>	<u>12</u>
1. Starting the Program.....	12
2. How to Connect to Next Gen PCS Filter.....	12
3. GUI Overview.....	13
4. Menu Items.....	15
5. Voltage Limit Set.....	17
6. Cycle Power Command.....	17
7. Enhanced Logging Mode.....	18
8. Graph Overview & Control.....	19
V. <u>Troubleshooting</u>	<u>23</u>
1. Next Gen PCS Filter.....	23
2. Diagnostic Software.....	24
VI. <u>Specifications</u>	<u>25</u>

I. NEXT GEN PCS PRODUCT OVERVIEW

The ESP Next Gen PCS is a state-of-the-art, microprocessor-controlled, hybrid power filter engineered with real-time data acquisition and storage.

Models: This manual applies to the following Next Gen PCS models:

Model Number	Voltage (AC RMS)	Current (AC Amps)	LCD	Outlet
XG-PCS-15D	120	15	Yes	
XG-PCS-20D	120	20	Yes	
XG-PCS-20815D	208/230 split phase	15	Yes	
XG-PCS-20820D	208/230 split phase	20	Yes	
XG-PCS-23013	230 single phase	13	Yes	
XG-PCS-L630	208/230 split phase	30	Yes	
XG-PCS-630	208/230 split phase	30	Yes	
XG-PCS-IK	Data Interface Kit: Volts and Amps not applicable			

Key Features:

- Industrial Strength Normal and Common Mode EMI Noise Filter
- Industrial Strength 3-Stage Normal and Common Mode AC Surge Suppressor
- ETL Certified CAT5e Network Line Surge Suppressor
- Modem/Fax Line Surge Suppressor
- Modem/Fax DSL Filter
- Zero-Voltage Turn-On
- Zero- Current Turn-Off
- Inrush Current Elimination (ICE[®])
- Wiring Fault Detection
- Catastrophic Over/Under Voltage Shutdown (CouVS[®]) with selectable thresholds
- Under-Voltage Event Recorder (up to 999 events)
- Over-Voltage Event Recorder (up to 999 events)
- Power Outage Event Recorder (up to 999 events)
- Surge Event Recorder (up to 999 events)
 - Records surges in all three modes: Line-Neutral, Line-Ground, Neutral-Ground (120V)
 - Records surges in all three modes: Line1-Line 2, Line1-Ground, Line2-Ground (208/230V)
- Event Timestamp Recorder (up to 60 events)
 - Records time between events
- LCD Event Monitor cycles through:
 - Under-Voltage Events
 - Over-Voltage Events
 - Power Outage Events
 - Surge Events
 - Last Recorded Event Type
 - Output Status (On or Off)
 - Additional information in certain circumstances (detailed in Section III: Hardware/Next Gen PCS Filter/LCD Event Monitor)
- Additional features available when connected to a PC (detailed in Section IV: Diagnostic Software)

Technical Support:

- To download software and access further product information, visit www.nextgenpcs.com or www.espei.com.
- **For Next Gen PCS technical support, please contact ESP at 1-800-645-9721.**

II. INSTALLATION INSTRUCTIONS

1. Next Gen PCS Filter Installation:

- a. Turn off the machine you are connecting to the Next Gen PCS Filter, and unplug the machine's power cord from wall outlet.
- b. Connect Modem/Fax line: Connect a phone cord from the wall jack to the "Modem/Fax" modular jack labeled "IN", and then connect a second phone cord from the "Modem/Fax" modular jack labeled "OUT" to the machine/equipment to be protected.



Please Note: *The Next Gen PCS Filter series only provides connectivity and protection for a single phone line – connecting the Filter to a phone jack with 2 lines using 4-conductor telephone cable may cause Filter malfunction, detailed in Section V: Troubleshooting/Next Gen PCS Filter Hardware.*

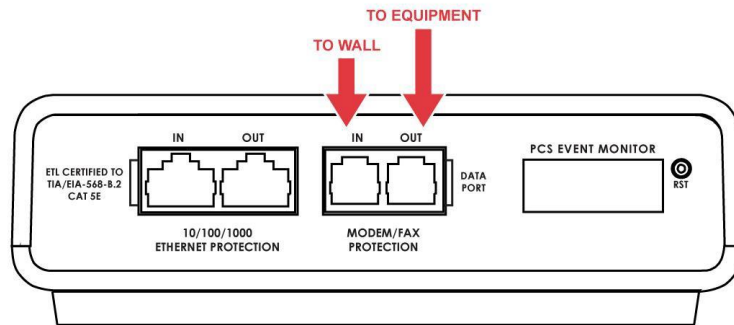

- c. Connect "10/100/1000 ETHERNET" network line: Connect a CAT5e network cable from the wall jack to the "10/100/1000 ETHERNET" modular jack labeled "IN", and connect a second CAT5e network cable from the "10/100/1000 ETHERNET" modular jack labeled "OUT" to the equipment to be protected.

One CAT5e network cable is included with the Next Gen PCS Filter.

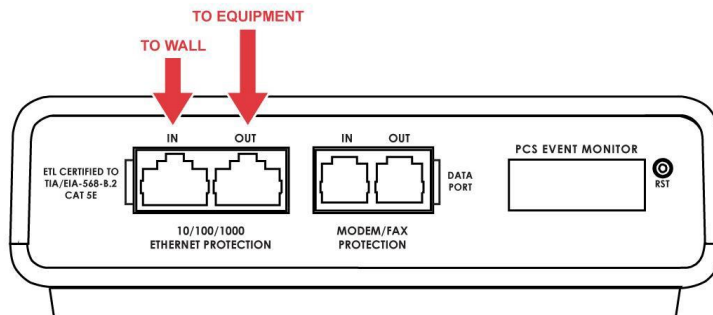

d. Connect Equipment

- i. Connect the AC power cord of the equipment to be protected into the short output power cord of the Next Gen PCS Filter.

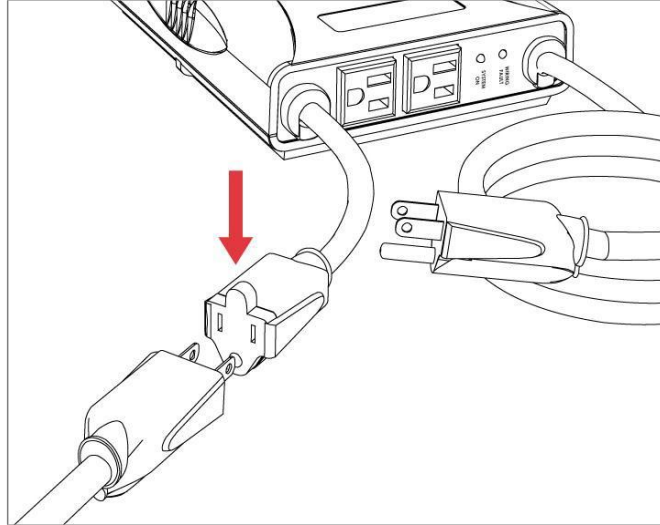

- ii. For 120V products and XG-PCS-23013: Connect the AC power cords of additional peripherals into the 2 convenience receptacles next to the short output power cord.

Make sure that the total amperage of all equipment plugged into the Next Gen PCS Filter does not exceed the maximum branch circuit rating.

Please Note: Exceeding the branch circuit rating will cause the branch circuit breaker to trip.

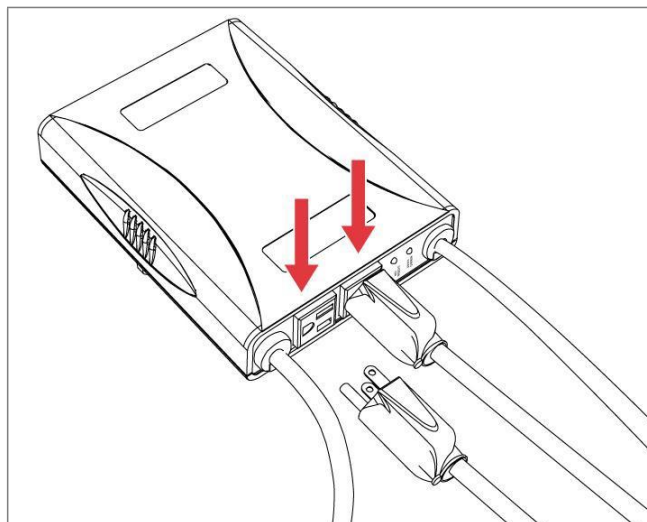

- e. Connect Next Gen PCS Filter to Outlet: Plug the Next Gen PCS Filter input power cord into a properly grounded and compatible branch circuit outlet.

Please Note: Do not plug the Filter into a re-locatable power tap.

- i. If the branch circuit outlet is correctly wired and the magnitude of the line voltage is acceptable (between 105 and 130 V_{RMS} for 120V products, or between 190 and 250 V_{RMS} for 208/230V products), power will be connected to the outlets of the Next Gen PCS Filter and the **Green** “System On” LED will illuminate. Your equipment is now protected and installed correctly. You may now turn all connected equipment back on.
- ii. If the branch circuit outlet is incorrectly wired, the **Red** “Wiring Fault” LED will illuminate and the LCD Event Monitor will display specific wiring fault information. If this occurs, contact a licensed electrician to correct the outlet wiring. Refer to Section III: Hardware/Next Gen PCS Filter, for LCD EVENT MONITOR display details.
- iii. If neither “System On”, nor the “Wiring Fault” LED illuminates, there is either no voltage at the receptacle or the magnitude of the line voltage is not acceptable (less than 105 V_{RMS} or above 130 V_{RMS} for 120V products, or less than 190 V_{RMS} or above 250 V_{RMS} for 208/230V products). If the magnitude of the line voltage is not acceptable, specific information will be displayed on the LCD EVENT MONITOR. If this occurs, contact a licensed electrician to trouble-shoot the abnormal voltage condition. Refer to Section III: Hardware/Next Gen PCS Filter, for LCD EVENT MONITOR display details.
 1. *You may also need to verify that the Filter is operating properly. To test, plug Next Gen PCS Filter into a known properly functioning outlet. If the “System On” LED still does not illuminate in the functioning outlet, contact ESP at 1-800-645-9721.*

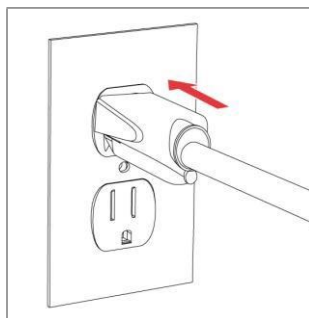

CAUTION – Do not install this device if there is not at least 10 meters (30 feet) or more of wire between the electrical outlet and the electrical service panel.

La PRUDENCE - n'installe pas cet artifice s'il n'y a pas au moins 10 mètres (30pieds) ou plus de fil entre l'issue électrique et le comité de service électrique.

2. Next Gen Data Interface Kit - PC and Driver Installation:

For Model XG-PCS-IK

Please Note:

- The Next Gen PCS Filter may be accessed by a PC while connected to AC power and equipment, or while disconnected from AC power and equipment.
- If accessed by a PC while connected to AC power: For best protection, it is recommended that the power cord of the computer is plugged into an available receptacle on the Next Gen PCS Filter.



Connecting the Next Gen PCS Filter to a PC allows for the availability of the following features:

- Import data stored in the Next Gen PCS Filter's device memory
- Import data from a stored data file
- Export data to a data file
- Export data to a report in PDF format
- Set over and under-voltage shutdown thresholds
- Clear device memory
- Real-time AC voltmeter
- Enhanced Logging Mode

Equipment required for PC communication:

- Next Gen PCS Filter
- Next Gen PCS Data Interface Cable
- Next Gen PCS Diagnostic Software (Revision 2.7)
- PC running Windows 2000 or later with a CD-ROM and USB port and a minimum screen resolution of 1024x768

a. Connect Next Gen PCS Data Interface Cable to your PC

- i. Plug the USB end of the Data Cable to an available USB port on your PC.



b. Install Next Gen PCS Driver Files

- i. Automatic (requires Internet connection)

When you plug the USB into your PC, Windows will automatically detect the cable.

1. When the "Found New Hardware" pop-up box appears, be sure to select "Yes, this time only" option for the device driver installation
2. This installation could take a few minutes to search and download the driver files. Once the files are found, follow the on-screen instructions to install.
3. Please Note: The drivers will first install the USB serial converter, and will then install the USB serial port drivers separately.

- ii. Manual

In the event that the automatic driver installation does not function or there is no internet connection, select "Install Drivers" during the Next Gen PCS Software Installation.

c. Configure PC Settings for COM Port

***Note: The COM Port Settings procedure has been automated in software version 2.7. See Section II – 3 – c – ii – 3 for details.**

i. Open Device Manager

1. Windows 2000 / XP
 - a. Click on **Start** and then select **Run**.
 - b. Type the following command in the “Open:” text box: **devmgmt.msc**
 - c. Click on the **OK** button.
 - d. Device Manager will display.
2. Windows 7 / Vista
 - a. Click on **Start** button
 - b. Type the following command in the “Search:” text box: **devmgmt.msc**
 - c. Click on the **OK** button.
 - d. Device Manager will display.

ii. In the Device Manager, Expand “Ports (COM & LPT)”

1. Locate the entry labeled “USB Serial Port (COM x)”, where x refers to the COM port number assigned by Windows.
2. Right-click on “USB Serial Port (COM x)” and click “Properties”.
3. USB Serial Port Properties pop-up box will display

iii. In the USB Serial Port Properties pop-up box:

1. Click the “Port Settings” tab, and then click the “Advanced” button.
 - a. If the “COM Port Number” is not between 1 and 9, change the assigned value to a value between 1 and 9.
 - i. **Make a note of the COM Port Number.**
It will be needed to configure the Diagnostic Software (as noted in Section II – 3 – C : Select COM Port.)
 - b. In “USB Transfer Sizes”, change both the “Receive” and “Transmit” values to 512.
 - c. In “BM Options”, change the “Latency Timer” value to 4.
 - d. Leave all other settings at default.

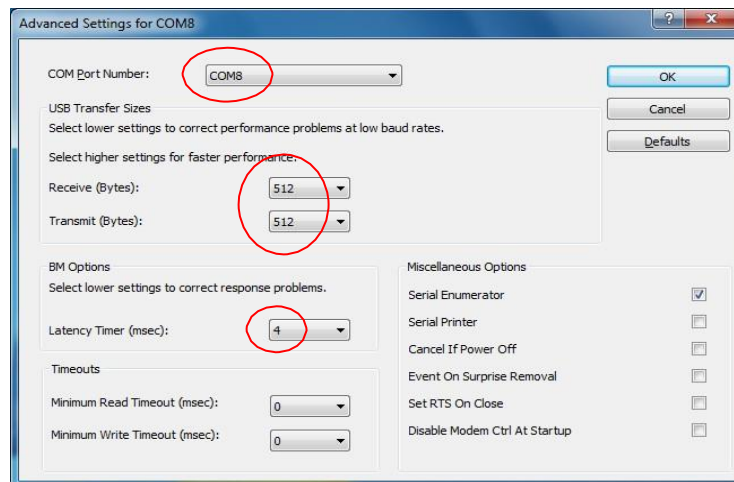

e. Press “OK”, and then press “OK” again.

iv. Close Device Manager.

3. Next Gen Data Interface Kit - Diagnostic Software Installation:

a. Install Software:

- i. Plug the USB end of the Data Cable to an available USB port on your PC.
- ii. Download Software Installer from www.espei.com.
- iii. Unzip and run the installation utility
- iv. Follow on-screen instructions to complete installation of the Next Gen PCS Diagnostic Software

b. Starting the program: Open the “ESP Next Gen PCS” Software on your PC (located under “Programs”). When you first open the program, it will look like the following. →

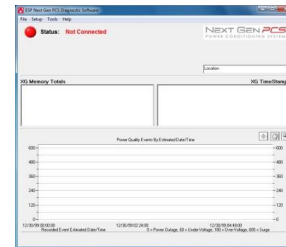

c. Select COM Port:

- i. Specify which COM port the Next Gen PCS Diagnostic Software should communicate through by navigating to “Setup/COM Port”.
 - 1. Be sure to use the same COM port number that was selected in Section II – 2 – C – iii: USB Serial Port Properties pop-up box
 - 2. The correct COM port number may be automatically detected by pressing the “Auto Detect” button while the Next Gen PCS and Data Interface Cable are connected to the computer.
 - 3. The COM Port Settings may be automatically configured by pressing the “Auto Configure” button. Windows Vista/7 users: For proper operation of this feature, right-click on the application shortcut and choose “Run As Administrator”.
- ii. In the window that appears, use the drop box to select the appropriate COM port, and press “Save”.

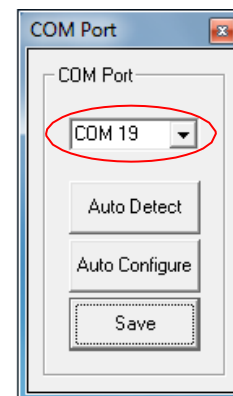
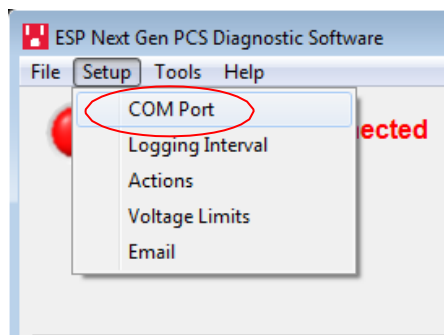

Your PC is now set up correctly to communicate with the Next Gen PCS Product Line.

III. HARDWARE

1. Next Gen PCS Filter

a. LCD Event Monitor



The LCD EVENT MONITOR displays useful information related to data collection, device status, and troubleshooting.

i. Normal Operation

1. When the Next Gen PCS Filter is plugged into a branch circuit outlet with correct wiring and acceptable line voltage, the LCD Event Monitor will cycle through the following information:

a. Number of recorded Under-Voltage events:



b. Number of recorded Over-Voltage events:



c. Number of recorded Power Outage events:



d. Number of recorded Surge events:



e. Last recorded Event type:





f. Outlet Status (On or OFF):





ii. Wiring Fault

When connected to an incorrectly wired branch circuit outlet, in addition to the illumination of the Red LED, the LCD Event Monitor will display the following information:

Wiring Fault Condition	Display	LCD EVENT MONITOR
Line (Hot) / Neutral Reversed (120V products only)	rP (Reverse Polarity)	
Missing Ground	gnd (no Ground)	

iii. Abnormal Voltage

When the magnitude of the branch circuit outlet voltage is not acceptable*, the Next Gen PCS Filter will disconnect power to its outlets and display the following information on the LCD Event Monitor (*above the over-voltage shutdown threshold or below the under-voltage shutdown threshold; refer to Section IV: Diagnostic Software for more information):

Voltage Condition	Display	LCD EVENT MONITOR
Over-Voltage	OFF + OVER	
Under-Voltage	OFF + UNDER	

b. Clearing Memory:

The Next Gen PCS Filter is able to timestamp the 60 most recent power quality events (information stored in microcontroller non-volatile memory). The microcontroller memory contents can be cleared at any time by following one of these two methods:

i. RST Button:

There is a recessed push button located on the far right of the front endplate (the end plate that contains the RJ45 and RJ11 and modular jacks).

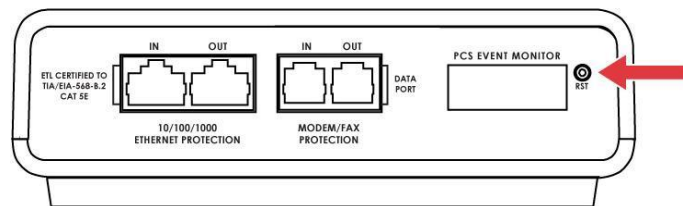

Follow these steps to clear the device memory:

1. Unplug the input cord of the Next Gen PCS Filter from the branch circuit outlet.
2. Using a paperclip or small screwdriver, press and hold the **RST** button.
3. Plug the input cord of the Next Gen PCS Filter into a properly grounded and compatible branch circuit outlet, while continuing to hold the **RST** button.
4. Wait approximately 3-5 seconds; the LCD Event Monitor will now display “cLr”; release the **RST** button and the device microcontroller memory will now be cleared.



ii. Diagnostic Software:

The device microcontroller memory may alternately be cleared from within the Diagnostic Software in the following location: “Tools/Clear Device Memory”. See Section IV– 4- C: Tools Menu, for details.

2. Next Gen PCS Data Interface Cable

a. Overview

- i. The Next Gen PCS Data Interface Cable consists of a USB connection on one end, and a RJ-11 connection on the opposite end.
- ii. The USB connection plugs into an available USB port on your PC. The RJ-11 connection plugs into the RJ-11 “OUT” Jack (labeled “Data Port”) on the Next Gen PCS Filter, which is the jack closest to the LCD Event Monitor and RST button.



b. Instructions for Data Retrieval

- i. Disconnect any protected Modem/Fax lines connected to the “IN” and “Out” RJ-11 modular jacks on the Next Gen PCS Filter. Ethernet connections (RJ-45) may remain in place. *(Skip this step for (XG-PCS-L630 / XG-PCS-630).*
- ii. Connect the Next Gen PCS Data Interface Cable into the USB port on your PC.
- iii. Connect the Next Gen PCS Data Interface Cable into the RJ-11 “OUT” Jack (labeled “Data Port”) on the Next Gen PCS Filter. It is the jack closest to the LCD Event Monitor and RST button.

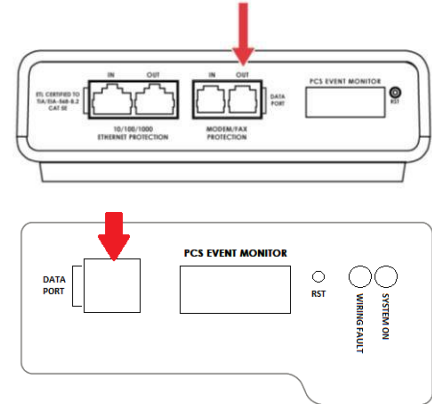

For (XG-PCS-L630 / XG-PCS-630):
Connect the Data Interface Cable into the RJ-11 jack labeled “Data Port” next to the LCD on the face of the unit.

- iv. Open Next Gen PCS Diagnostic Software.
- v. When you are finished, be sure to re-connect the Modem/Fax lines to the “IN” and “Out” RJ-11 modular jacks on the Next Gen PCS Filter.

IV. DIAGNOSTIC SOFTWARE

1. Starting the Program:

Open the “ESP Next Gen PCS” Diagnostic Software (located under “Programs” on your PC Start Menu).

- a. Please Note: A shortcut to this manual will also be located in this location on your PC for future reference and troubleshooting.

2. How to Connect to the Next Gen PCS Filter:

- a. Make sure that the USB Data Cable is connected to both the Next Gen PCS Filter and your PC (for instructions on how to connect USB Data Cable, refer to Section III – 2 - B : Hardware/USB Data Interface Cable/Instructions for Data Retrieval – listed above)
- b. Press the red button beside “Status” to connect to the Next Gen PCS Filter. The Connection Status will change to **Green** and the top of the screen will indicate that Filter is **Connected**.

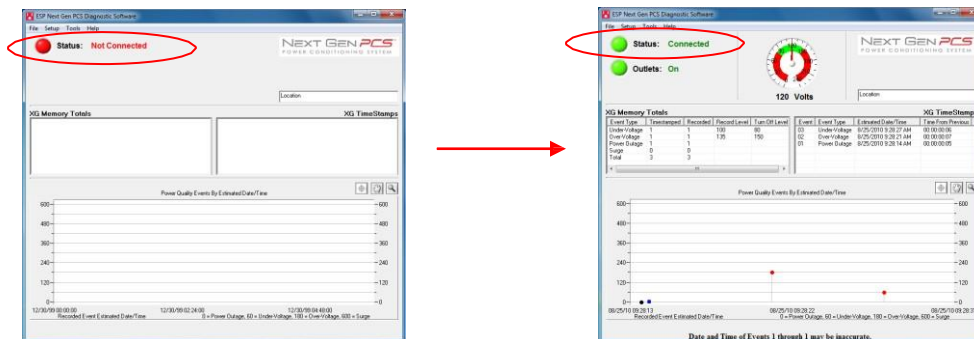

3. GUI Overview:

After connecting successfully, several pieces of information gathered from the Next Gen PCS Filter will now be displayed on the Diagnostic Software Graphical User Interface.

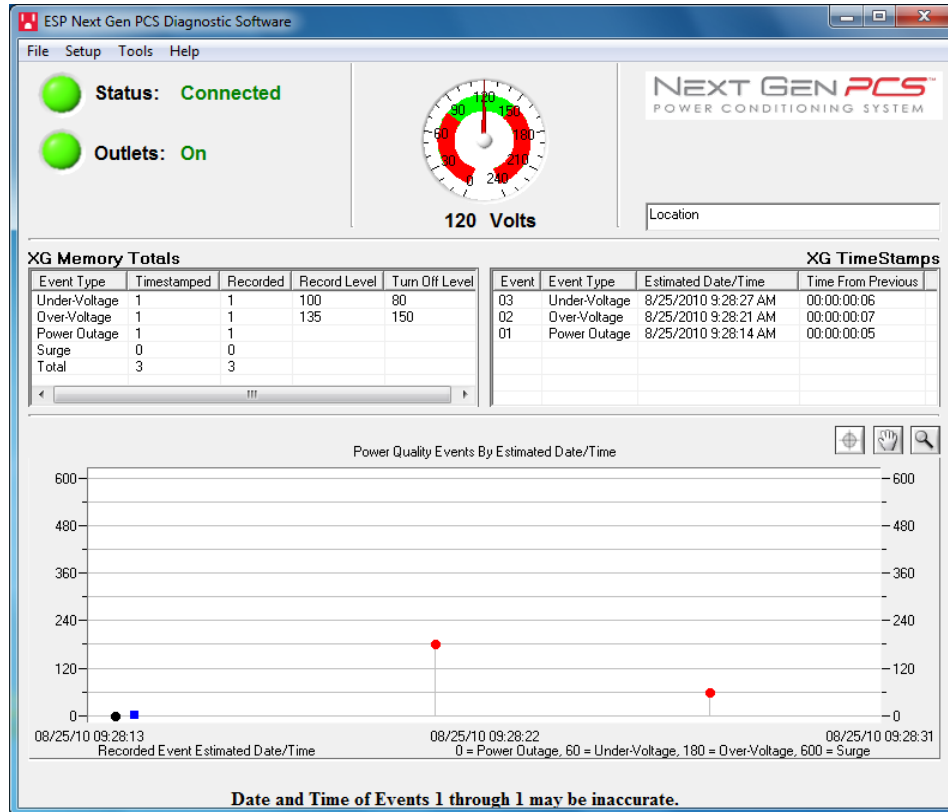

- Connection Status: The current connection status is displayed to the right of the Connect/Disconnect button.
- Disconnect: Pressing the green button beside "Status" will terminate communications with the Next Gen PCS Filter.
- Location Textbox: The text entered in the textbox is included with data that is exported to a file.
- Voltmeter: A real-time AC Voltmeter is displayed in the upper center, which displays the line voltage both numerically and as an analog meter.

- e. Outlet Status: Outlet Status is displayed below Connection Status. The current state of the outlets is displayed (either On or Off), and pressing the On/Off button will manually turn the output On and Off. When connected to the Next Gen PCS Filter during an abnormal voltage condition (power outage, under-voltage, or over-voltage), wiring fault (Reverse Polarity [Live/Neutral reversed], or Missing Ground), the On/Off outlet control is not available, and the corresponding abnormal voltage/wiring fault condition will be displayed beside the outlet status. **A ground connection may be made through the computer connection. It is recommended to determine the outlet wiring status with the Next Gen PCS Filter before connecting the Next Gen PCS Data Interface Cable, or to use a laptop computer with its charger disconnected.*

- f. Recorded Data Display: The lower portion of the screen is a display of the data recorded and stored in the Next Gen PCS Filter's internal memory. Power quality event totals are listed in the "XG Memory Totals" table. The events are listed in the "XG Time Stamps" table in order of occurrence (with the most recent events at the top) with their corresponding estimated date and time of occurrence. The events are also graphically displayed on the "Power Quality Events By Estimated Date/Time" graph in order of occurrence by estimated date and time (the Next Gen PCS Filter does not currently record the duration of a power outage event). If additional power quality events are recorded while connected to the Next Gen PCS Filter, the data display will automatically update with the new information. The Next Gen PCS Filter Microcontroller can record up to 999 occurrences of each of the following:
 - i. Over-Voltage Events
 - ii. Under-Voltage Events
 - iii. Power Outage Events
 - iv. Surge Events

- g. Timestamps: In addition to the Recorded Data events, the Next Gen PCS Filter microcontroller also timestamps up to 60 recorded events.
 - i. The timestamp is a record of the elapsed time (up to 99 Days, 23 Hours, 59 Minutes, and 59 seconds) since the last recorded event – this is the time difference between subsequent events, not the elapsed time from an initial starting point. Please note: The amount of elapsed time during power outages is not recorded.
 - ii. The Next Gen PCS Diagnostic Software estimates the actual date and time of each event occurrence based on the recorded time difference between events, and the current date and time of the connected computer.
 - iii. The graph uses the values of 0%, 50%, 150%, and 600% for graphical display of power outages, under-voltages, over-voltages, and surge events, respectively; the actual voltages during these events are not recorded and probably differ from the graphical values (0%, 50%, 150%, and 600%) shown.

4. **Menu Items:**

a. **File Menu:**

- i. **Import Data From XG:** Manually import data stored in the Next Gen PCS Filter's internal memory.
- ii. **Import Data From File:** Import data from a previously stored data file. Does not require Next Gen PCS Filter connectivity.
- iii. **Export Data To File:** Exports the currently displayed data to a data file, which can be imported for future viewing. The data file may be saved as text (.txt) or comma-separated (.csv, suitable for viewing in MS Excel). Including the Enhanced Logging Mode data is optional.
- iv. **Save Report:** Saves a summary report of the currently displayed data in PDF format.
- v. **Save Image:** Saves a screenshot of the program as an image (.bmp) file.
- vi. **Print:** Prints a screenshot of the program.
- vii. **Exit:** Terminates connectivity with any connected Next Gen PCS Filter and exits the program.

b. **Setup Menu:**

- i. **COM Port:** Selects which COM port the PCS program should connect through. The COM port selection is saved to a configuration file, and does not need to be chosen again the next time the program is run (unless a new Next Gen PCS Data Interface Cable is used).
- ii. **Logging Interval:** Allows for the selection of the logging time interval between acquired line voltage data points when using the Enhanced Logging Mode feature. The logging time interval selections available are: 1 second, 2 seconds, 4 seconds, 10 seconds, and 30 seconds. When the line voltage is changing rapidly, additional data points will be recorded, regardless of the time interval selection.
- iii. **Actions:** Allows for the selection of which new event(s) will result in the sending of an email. *This feature is only available when the Next Gen PCS is connected to a PC with an internet connection and the Next Gen PCS software running.*

- iv. Voltage Limits: Displays the over-voltage and under-voltage shutdown thresholds currently in use, and allows for the selection of alternate values. **When Under-Voltage Shutdown is Disabled, the Next Gen PCS Filter will not actively shut off connected equipment during an under-voltage event. However, the Next Gen PCS Filter's power relays will drop out and disconnect equipment around 40V. This is because there is not enough voltage available to keep the relays latched.*
 - v. Email: Allows for the configuration of email settings. The software is pre-loaded with "courtesy account" settings that may be used for testing purposes. *The email feature is only available when the Next Gen PCS is connected to a PC with an internet connection and the Next Gen PCS software running. This feature may not work with certain Internet Service Providers that block outgoing SMTP communications – check with your ISP for compatibility. Please contact your IT staff for assistance when configuring custom email settings.*
 - c. Tools Menu:
 - i. Cycle Power: Commands the Next Gen PCS Filter to perform a Power Cycle.
 - ii. Clear Device Memory: Permanently erases the events and timestamps contained in the Next Gen PCS Filter's microcontroller memory. Clearing the device memory does not affect Voltage Thresholds.
 - iii. Enhanced Logging Mode: Puts the Next Gen PCS Filter into Enhanced Logging Mode.
 - d. Help Menu:
 - i. Help Topics: Launches the Next Gen PCS Help, which includes troubleshooting information for the Next Gen PCS product and software, FAQ, and general information about Power Quality.
 - ii. Manual: Launches the Next Gen PCS Manual that is installed with the software package.
 - iii. About: Displays the software revision of the Next Gen PCS Diagnostic Software program, the firmware revision of the microcontroller in the connected Next Gen PCS Filter, the unique chip ID of the microcontroller in the connected Next Gen PCS Filter, and ESP's telephone number for technical support.

5. Voltage Limit Selection

- a. Navigate to “Setup/Voltage Limits” in the menu.
- b. The Voltage Limit selection screen will appear with the currently active limits selected:

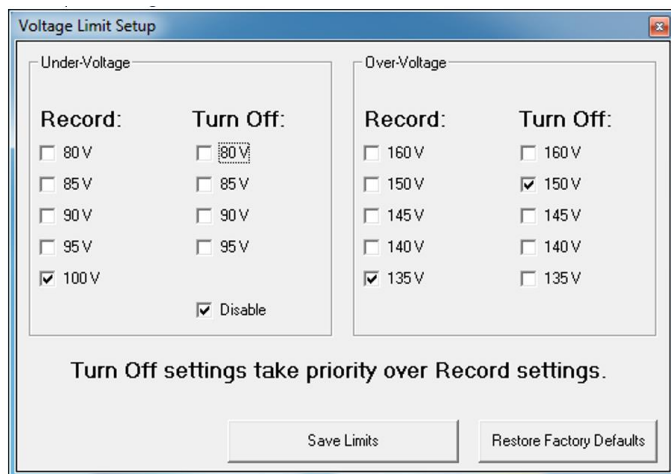

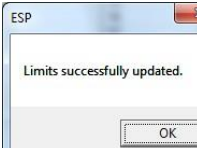
- c. To change the limits, check the boxes beside the desired values and press “Save Limits”.
- d. When the new limits have been successfully saved in the Next Gen PCS Filter, the following message will be displayed: 
- e. Press “OK” to complete the voltage limit selection process.

6. Cycle Power Command

- a. In addition to basic On/Off outlet control, the Next Gen PCS Diagnostic Software includes the ability to execute a power cycle.
- b. When commanded, the outlets will turn Off, then back On, after a 90 second delay time.
- c. To perform a power cycle, navigate to “Tools/Cycle Power” in the menu. The software will explain that performing a power cycle will turn off power to connected equipment for 90 seconds. Press “Ok” to continue, or “Cancel” to cancel.
- d. During the cycle, a progress bar will appear which will indicate the time until the outlets are turned back On:

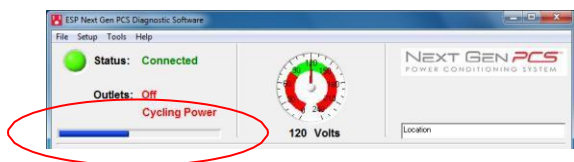

- e. While the Next Gen PCS Filter is performing a power cycle, its LCD EVENT MONITOR will display “cYc” instead of “On” or “OFF”:



7. Enhanced Logging Mode

- a. The Enhanced Logging Mode function of the Next Gen PCS Diagnostic Software extends the logging and monitoring capabilities of the Next Gen PCS Filter while a PC is connected.
- b. **Enhanced Logging Mode can be started by navigating to “Tools/Enhanced Logging Mode”.**
 - i. The additional features available with the Enhanced Logging Mode are:
 - 1. Logging of individual line voltage measurements
 - a. The magnitude of the line voltage of each data acquisition point is recorded.
 - b. The date and time of each data acquisition point is recorded (based on Windows system time).
 - c. Adjustable logging interval. The time interval choices are 1, 2, 4, 10, or 30 seconds between data acquisition points.
 - d. If the line voltage is changing rapidly (faster than 2V/0.2 seconds), new data points will be recorded, regardless of the logging interval selection.
 - e. The line voltage is displayed visually, graphed against the current date and time (based on Windows system time).
 - 2. Date and Time stamping of new events recorded by the Next Gen PCS Filter
 - a. The date and time of each new power quality event recorded by the Next Gen PCS Filter’s microprocessor is recorded (based on Windows system time).
 - 3. Graph Display
 - a. The graph displaying the power quality events recorded by the Next Gen PCS Filter will be replaced by a graph of the line voltage (“Line Voltage History”)
 - b. The table (“XG TimeStamps”) displaying the time stamps of the power quality events recorded by the Next Gen PCS Filter will be replaced by a table (“ELM TimeStamps”) displaying the power quality events recorded by the Next Gen PCS Filter while in Enhanced Logging Mode.



8. Graph Overview

a. Graph Control

- i. The graphs used to display the recorded power quality events (normal mode) and line voltage (Enhanced Logging Mode) contain Zoom, Cross Hair, and Drag functions that are useful when analyzing data:



Legend: Press the L icon to display the Graph Legend to show the values of the Time Stamped data. Pressing the icon again toggles the legend off.



Zoom: Press the magnifying glass icon to enable Zoom mode. Pressing the icon again stops Zoom mode, and restores the graph to its full display scale.



Cross Hair: Turns the cross hair on and off.



Drag: Enables/Disables Drag mode. When in Drag mode, press and hold the left mouse button somewhere on the graph, and move the mouse. The graph will be dragged in the corresponding direction.

- ii. Several control buttons are available below the graphs, depending on which mode is active:
 1. G1/G2: Toggles between Graph 1 (recorded power quality events) and Graph 2 (line voltage). Available after entering Enhanced Logging Mode.
 2. **/--: Toggles the data display of Graph 2 (line voltage) between linear and discrete data points. Available when Graph 2 is visible.
 3. Stop: Stops Enhanced Logging Mode. Available after entering Enhanced Logging Mode.

b. Graph Data

i. Power Quality Events Graph

1. Overview

- a. The recorded power quality events graph displays the time-stamped power quality events (up to 60) recorded and stored in the Next Gen PCS Filter's internal memory. The events are plotted as individual data points.
- b. While the events are time-stamped in the Next Gen PCS Filter's internal memory by the elapsed time since the previous recorded event, they are plotted on the graph with an estimated date and time, based on the connected computer's Windows system time. The duration of a power outage is not recorded, so the date and time of events prior to and including the most recent power outage may not be accurate. Events with an accurate estimated date and time are plotted with a red circle; events with a possibly inaccurate date and time are plotted with a black circle; the time the computer was connected is plotted with a blue square.

- c. All events recorded while a computer is connected to the Next Gen PCS Filter will have an accurate date and time stamp, since the computer will supply power to the Next Gen PCS Filter's microcontroller in the event of a power outage (as long as the computer stays on).
 - d. The graph uses the values of 0%, 50%, 150%, and 600% for graphical display of power outages, under-voltages, over-voltages, and surge events, respectively; the actual voltages during these events are not recorded and probably differ from the graphical values (0%, 50%, 150%, and 600%) shown.
2. **Zoom Function:** The recorded power quality events graph may be zoomed along the X (time) axis. To zoom in on an area of the graph, press the magnifying glass icon, press and hold the left mouse button somewhere on the graph, then drag the cursor either left or right to define the zoom selection, and then release the left mouse button. The graph will now display the selected area. Press the magnifying glass icon again to restore the original full display.

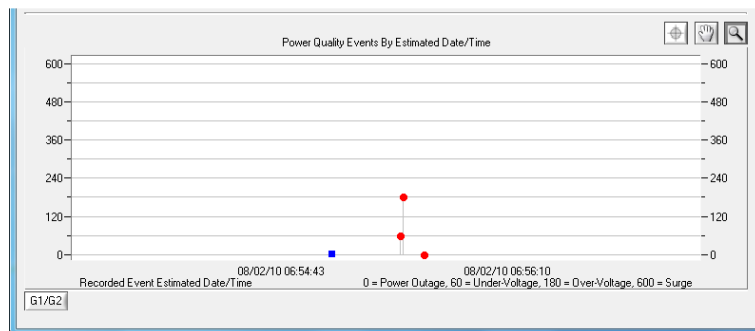
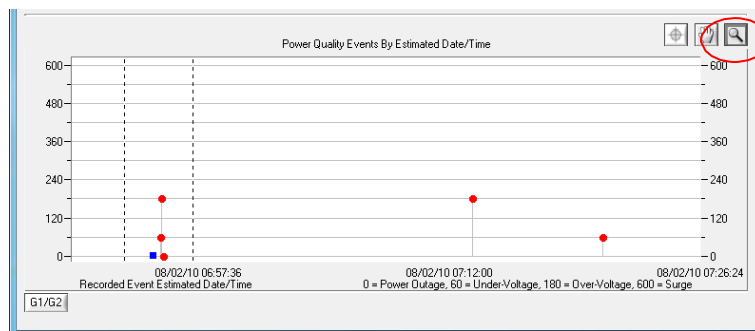

3. Cross Hair Function: The cross hair tool is useful when determining the estimated date/time of an event, as well as the type of the event. Pressing the cross hair icon will place a cross hair on one of the graph's data points, and the corresponding date/time and type of that event will be displayed when the mouse pointer hovers over that point:

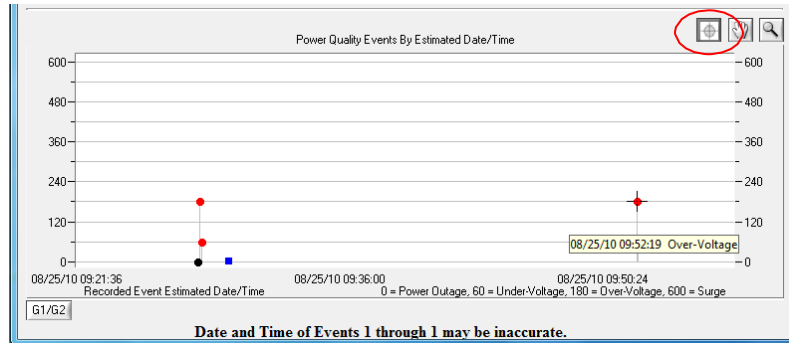

To move the cross hair to a different data point, simply position the mouse pointer over the data point of interest.

ii. Enhanced Logging Mode Line Voltage Graph:

The Enhanced Logging Mode line voltage graph displays the recorded line voltage in a strip chart style. Each voltage measurement is a discrete data point containing the magnitude of the line voltage and the date and time (based on Windows system time) of the measurement. Data points are acquired at a time interval determined by the selection made in "Setup/Logging Interval". The choices are 1 point per second, 1 point per 2 seconds, 1 point per 4 seconds, 1 point per 10 seconds, or 1 point per 30 seconds. If the line voltage is changing rapidly (faster than 2V in 0.2 seconds), data points will be recorded at a faster rate, regardless of the interval selection.

1. Point/Line (**/-- button) Toggle: The style of the graph can be toggled between individual data points and linear by pressing the "**/--" button.

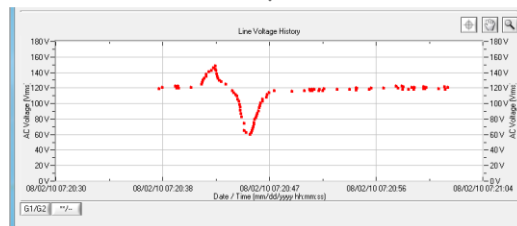
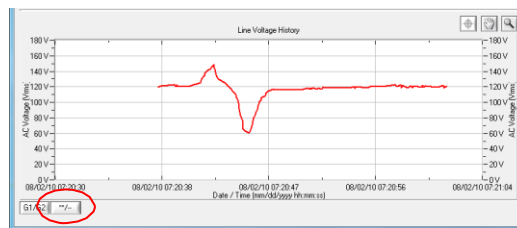

2. **Zoom Function:** The line voltage graph may be zoomed along both the X (time) and Y (Voltage) axes. To zoom in on an area of the graph, press the magnifying glass icon, press and hold the left mouse button somewhere on the graph, drag the cursor to define the zoom selection, and then release the left mouse button. The graph will now display the selected area. Press the magnifying glass icon to restore the original full display.

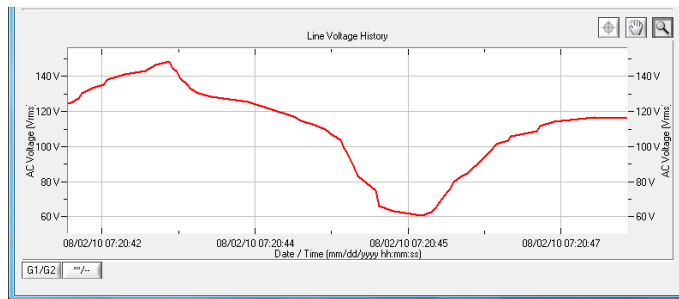
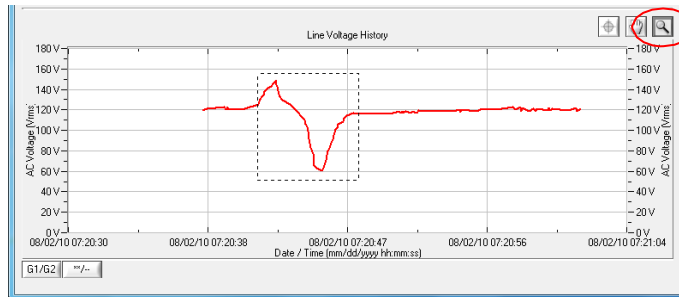

3. **Cross Hair Function:** The cross hair tool is useful when determining the magnitude and date/time of a line voltage measurement. Press the cross hair icon to place a cross hair on one of the graph's data points, and the corresponding date, time, and magnitude of that data point will be displayed when the mouse pointer hovers over that point:

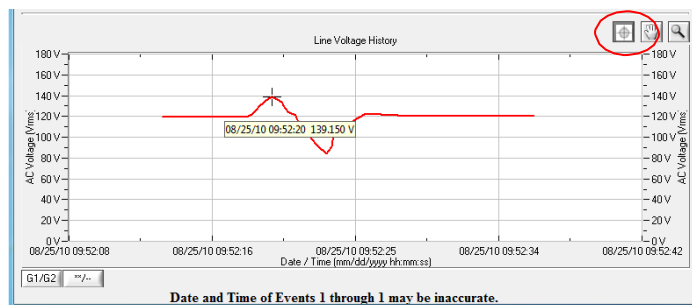

To move the cross hair to a different data point, simply position the mouse pointer over the data point of interest.

V. Troubleshooting

The Next Gen PCS Filter and Data Interface Cable contain no user-serviceable parts. Do not attempt product disassembly, as this will void the product warranty.

1. Next Gen PCS Filter:

Symptom	Possible Cause	What To Do
Red LED On, Green LED Off, No power at output.	Incorrectly wired branch circuit outlet. If using a Next Gen PCS Filter (D models only), the LCD EVENT MONITOR will display the nature of the wiring fault.	Contact a licensed electrician to correct the branch circuit outlet wiring.
Red LED Off, Green LED Off, No power at output.	No voltage or unacceptable voltage at branch circuit outlet, or Next Gen PCS Filter output manually turned Off.	If using a Next Gen PCS Filter (D models only) and the LCD EVENT MONITOR is not on, there is no power at the wall receptacle. If the voltage is unacceptable, the LCD EVENT MONITOR will display the type of voltage condition. Use the Communications Software to measure the voltage at the wall receptacle. Contact a licensed electrician to troubleshoot the wall receptacle. Use the Communications Software to manually turn the outlets On. Alternately, press and release the RST button once to manually turn the outlets On.
Red LED Off, Green LED On, No power at output.	Defective product.	Contact ESP for product replacement at 800.645.9721.
Red LED Off, Green LED cycles On and Off, Power at output cycles On and Off, LCD EVENT MONITOR blank	The Next Gen PCS Filter's Modem/Fax RJ-11 modular jack is connected to a phone jack with 2 lines through a 4-conductor phone cord.	Replace the 4-conductor phone cord with a 2-conductor phone cord, then connect the wall jack to the IN port, and the equipment to the OUT port.
Red LED Off, Green LED Off, No Power at output, LCD EVENT MONITOR blank	The Next Gen PCS's Modem/Fax RJ-11 modular jack is connected to a phone jack with 2 lines through a 4-conductor phone cord.	Replace the 4-conductor phone cord with a 2-conductor phone cord, then connect the wall jack to the IN port, and the equipment to the OUT port.

2. Next Gen PCS Diagnostic Software:

Symptom	Possible Cause	What To Do
Receive error related to .ocx or .dll file when attempting to start software.	ActiveX control not installed.	Refer to Section II: Installation Instructions/Software Installation and Section IV: Diagnostic Software for instructions on re-installing the Next Gen PCS Diagnostic Software.
Part of the program screen is not visible on the computer monitor.	The computer's screen resolution is set too low.	Set the computer's screen resolution to a minimum of 1024x768.
Software will not connect to Next Gen PCS Filter.	Correct COM port is not selected, Next Gen PCS Data Interface Cable is not connected, Serial-USB drivers are not installed, or Next Gen PCS Data Interface Cable is connected to wrong port on Next Gen PCS Filter.	Verify all connections and set the correct COM port, as detailed in Section II: Installation Instructions.
Software will not send email.	Email settings are incorrect, computer does not have an internet connection, ISP blocks outgoing SMTP communications.	Verify that email settings are correct. Verify that the computer is connected to the internet. Contact ISP regarding policies on outgoing SMTP communications.
COM Port specification is not saved/retained	Windows Vista/7/8 User Account Control requires software to run with administrative rights	Right-click the "ESP Next Gen PCS" desktop shortcut, click "Troubleshoot Compatibility", and follow the on-screen instructions.

VI. Specifications

Parameter		Specification	
Load Rating	XG-PCS-15D	15 Amps at 120 Volts	
	XG-PCS-20D	20 Amps at 120 Volts	
	XG-PCS-20815D	15 Amps at 120/230 Volts Split Phase	
	XG-PCS-20820D	20 Amps at 120/230 Volts Split Phase	
	XG-PCS-23013	13 Amps at 230V Single Phase	
	XG-PCS-L630	30 Amps at 120/230 Volts Split Phase	
	XG-PCS-630	30 Amps at 120/230 Volts Split Phase	
Voltage Protection Rating (VPR)	XG-PCS-15D	330V All Modes	
	XG-PCS-20D		
	XG-PCS-20815D	800V Line-Line	
	XG-PCS-20820D	500V Line-Ground	
	XG-PCS-23013	N/A	
Attenuation	Normal Mode	XG-PCS-15D	> 30 dB 80kHz – 50MHz
		XG-PCS-20D	
		XG-PCS-20815D	
		XG-PCS-20820D	
		XG-PCS-23013	
		XG-PCS-L630	
		XG-PCS-630	
	Common Mode	XG-PCS-15D	> 30 dB 70kHz – 50MHz
		XG-PCS-20D	> 30 dB 200 kHz – 50MHz
		XG-PCS-20815D	
XG-PCS-20820D	XG-PCS-23013	XG-PCS-L630	XG-PCS-630
XG-PCS-20D			
XG-PCS-20815D			
XG-PCS-20820D			
XG-PCS-23013			
XG-PCS-L630	6 Watts		
XG-PCS-630			
Under-Voltage Shutdown	120V Models	Adjustable from 80V to 95 V, or Disabled. Restores at 105V.	
	208/230V Models	Adjustable from 140V to 170 V, or Disabled. Restores at 190V.	
Over-Voltage Shutdown	120V Models	Adjustable from 135V to 160V. Restores at 130V.	
	208/230V Models	Adjustable from 260V to 300V. Restores at 250V.	
Internal Memory Capacity		60 Events with timestamp; 999 counts of each event type	
Timestamp Accuracy		±2.5%	
Voltmeter Accuracy (Peak Reading Type)	120V Models	± 2% Typical product accuracy between 40V and 180V	
	208/230V Models	± 2% Typical product accuracy between 100V and 300V	
Response Time	Over-Voltage	100 msec	
	Under-Voltage	150 msec	
Under-Voltage Record Definition	120V Models	AC Voltage has dropped below 100V	
	208/230V Models	AC Voltage has dropped below 180V	
Over-Voltage Record Definition	120V Models	AC Voltage has risen above 135V	
	208/230V Models	AC Voltage has risen above 260V	
Power Outage Event Definition		AC Voltage has dropped below 20V	

Parameter		Specification
Surge Event Definition		Next Gen PCS has been exposed to a transient voltage in one of the 3 possible modes (between Live and Neutral, between Live and Ground, between Neutral and Ground) with a peak amplitude of 500V-700V* or higher and a frequency of 20 kHz or higher. *500V-700V surge voltage amplitude applies to IEEE C62.41 Category B Impulse; surge voltage amplitudes necessary for detection of other surge types may vary.
Modem/Fax Protection		Single telephone line surge suppression
Ethernet Protection		Cat5e network surge protection, ETL Certified to TIA/EIA-568-B.2
Computer Requirements		For use with Next Gen PCS Diagnostic Software. Minimum 133MHz Pentium processor (or equivalent), minimum 64MB of RAM, minimum 10MB free hard drive space, VGA or higher resolution monitor, keyboard, mouse, CD or DVD drive, minimum screen resolution of 1024x768, Microsoft Windows
Temperature Range		5C to 35C
Humidity Range		5% to 95% R.H. Non-condensing
Dimensions	XG-PCS-15D XG-PCS-20D XG-PCS-20815D XG-PCS-20820D XG-PCS-23013	6.125" W x 8.375" D x 2" H
	XG-PCS-L630 XG-PCS-630	7.75" W x 4.5" D x 11.25" H
Weight	XG-PCS-15D XG-PCS-20D XG-PCS-23013	2.4 lbs.
	XG-PCS-20815D XG-PCS-20820D	2.6 lbs.
	XG-PCS-L630 XG-PCS-630	10 lbs.
Agency Listings	XG-PCS-15D XG-PCS-20D	Conforms to UL1449 3rd Edition Conforms to UL1283 Certified to CSA Std C22.2 No. 8 ETL Certified to TIA/EIA-568-B.2 Cat 5e Industry Canada Certified
	XG-PCS-20815D XG-PCS-20820D XG-PCS-L630 XG-PCS-630	Conforms to UL1449 3rd Edition Certified to CSA Std C22.2 No. 8 ETL Certified to TIA/EIA-568-B.2 Cat 5e Industry Canada Certified
	XG-PCS-23013	In Process

** Specifications subject to change without notice

** All listed specifications obtained at an ambient temperature of 25°C